



# The Engineer's Guide to Tank Gauging

2017 EDITION



**What is tank gauging?**

**Tank gauging technologies**

**Engineering standards and approvals**

**Volume and mass assessment**

**Accuracies and uncertainties**

**Temperature measurement**

**Liquefied gases**

**Additional sensors**

**System architecture**

**Overfill prevention**

**Appendix: Typical tank gauging configurations**

**References**







## Legal disclaimer

---

This book is designed to provide information on tank gauging only.

This information is provided with the knowledge that the publisher and author are offering generic advice which may not be applicable in every situation. You should therefore ensure you seek advice from an appropriate professional.

This book does not contain all information available on the subject. This book has not been created to be specific to any individual's or organizations' situation or needs. Every effort has been made to make this book as accurate as possible. However, there may be typographical and or content errors. This book contains information that might be dated. While we work to keep the information up-to-date and correct, we make no representations or warranties of any kind, expressed or implied, about the completeness, accuracy, reliability, suitability or availability with respect to the book or the information, products, services, or related graphics contained in the book or report for any purpose. Any reliance you place on such information is therefore strictly at your own risk. Therefore, this book should serve only as a general guide and not as the ultimate source of subject information. In no event will we be liable for any loss or damage including without limitation, indirect or consequential loss or damage, arising out of or in connection with the use of this information. You hereby agree to be bound by this disclaimer or you may return this book.

All rights reserved. No part of this book may be reproduced or transmitted in any form or by any means, electronic or mechanical, including photocopying, recording or by any information storage and retrieval system, without written permission from the author.



## Table of contents

---

|     |   |    |
|-----|---|----|
| 1.  | What is tank gauging?                         | 1  |
| 2.  | Tank gauging technologies                     | 7  |
| 3.  | Engineering standards and approvals           | 15 |
| 4.  | Volume and mass assessment                    | 27 |
| 5.  | Accuracies and uncertainties                  | 33 |
| 6.  | Temperature measurement                       | 41 |
| 7.  | Liquefied gases                               | 47 |
| 8.  | Additional sensors                            | 51 |
| 9.  | System architecture                           | 55 |
| 10. | Overfill prevention                           | 63 |
| 11. | Appendix: Typical tank gauging configurations | 71 |
| 12. | References                                    | 89 |



# Abbreviations

|                 |  |             |   |
|-----------------|--|-------------|---|
| <b>AOPS</b>     | Automatic Overfill Prevention System           | <b>MPMS</b> | Manual of Petroleum Measurement Standards   |
| <b>API</b>      | American Petroleum Institute                   | <b>MTBF</b> | Mean Time Between Failures  |
| <b>ATG</b>      | Automatic Tank Gauge                           | <b>NIST</b> | National Institute of Standards and Technology  |
| <b>ATT</b>      | Automatic Tank Thermometer                     | <b>NMi</b>  | Nederlands Meetinstituut  |
| <b>BEV</b>      | Bundesamt für Eich- und Vermessungswesen       | <b>NSV</b>  | Net Standard Volume   |
| <b>BS&amp;W</b> | Base Sediment & Water                          | <b>OIML</b> | International Organization of Legal Metrology   |
| <b>DCS</b>      | Distributed Control System                     | <b>OPS</b>  | Overfill Prevention System  |
| <b>EMC</b>      | Electromagnetic Compatibility                  | <b>PLC</b>  | Programmable Logic Controller   |
| <b>EODR</b>     | Electro-Optical Distance Ranging               | <b>PTB</b>  | Physikalisch-Technische Bundesinstitut  |
| <b>FMCW</b>     | Frequency Modulated Continuous Wave            | <b>R 85</b> | Recommendation 85, a special procedure for testing of tank gauging equipment defined by OIML. |
| <b>FWL</b>      | Free Water Level                               | <b>RRF</b>  | Risk Reduction Factor   |
| <b>FWV</b>      | Free Water Volume                              | <b>RTD</b>  | Resistance Temperature Detector   |
| <b>GOV</b>      | Gross Observed Volume                          | <b>SAT</b>  | Site Acceptance Testing   |
| <b>GSV</b>      | Gross Standard Volume                          | <b>SIF</b>  | Safety Instrumented Functions   |
| <b>HTG</b>      | Hydrostatic Tank Gauging                       | <b>SIL</b>  | Safety Integrity Level  |
| <b>IEC</b>      | International Electrotechnical Commission      | <b>SP</b>   | Technical Research Institute of Sweden  |
| <b>ISO</b>      | International Organization for Standardization | <b>TCT</b>  | Tank Capacity Table   |
| <b>LNE</b>      | Laboratoire national de métrologie et d'essais | <b>TOV</b>  | Total Observed Volume   |
| <b>LNG</b>      | Liquefied Natural Gas                          | <b>VCF</b>  | Volume Correction Factor  |
| <b>LPG</b>      | Liquefied Petroleum Gas                        | <b>WiA</b>  | Weight in Air   |
| <b>LTD</b>      | Level Temperature Density                      | <b>WiV</b>  | Weight in Vacuum  |
| <b>MOPS</b>     | Manual Overfill Prevention System              |             |   |
| <b>MPE</b>      | Maximum Permissible Error                      |             |   |





# 1

## What is tank gauging?

| Topic                                | Page |
|--------------------------------------|------|
| 1.1 Tank gauging is a system science | 2    |
| 1.2 Where is tank gauging used?      | 3    |
| 1.3 The purpose of tank gauging      | 4    |
| 1.3.1 Oil movement and operations    | 4    |
| 1.3.2 Inventory control              | 5    |
| 1.3.3 Custody transfer               | 5    |
| 1.3.4 Loss control and mass balance  | 5    |
| 1.3.5 Overfill prevention            | 5    |
| 1.3.6 Leak detection                 | 6    |
| 1.3.7 Volume reconciliation          | 6    |

# 1. What is tank gauging?

Tank gauging is the measurement of liquids in large storage tanks with the purpose of quantifying the volume and mass of the product in the tanks.

The oil and gas industry generally uses static volumetric assessments of the tank content. This involves level, temperature and pressure measurements. There are different ways of measuring the liquid level and other properties of the liquid. The measurement method depends on the type of tank, the type of liquid and the way the tank is used.

Besides precision level gauging, temperature measurements are essential in assessing tank contents accurately. All liquids have a thermal expansion coefficient and proper volume compensation needs to be applied when transferring volumes at different temperature conditions. A pressure measurement of the liquid head is often added to provide a current assessment of the average observed density and to calculate the product mass.

Modern tank gauging systems digitize the tank measurement and digitally transmit the tank information to a control room where the liquid volume and mass information is distributed to users of the inventory data.

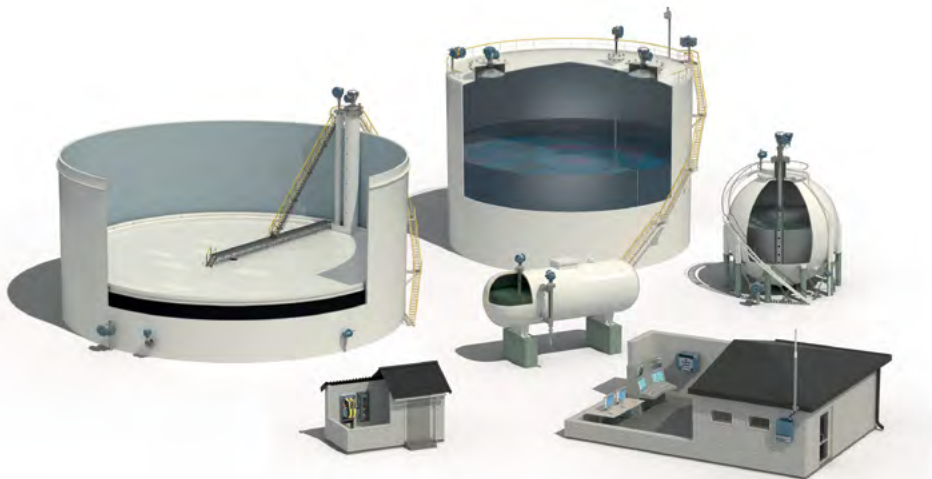

Storage tanks can contain large volumes of liquid product representing a significant value. The accuracy performance of a tank gauging system is of high importance when assessing the tank content at any given time.

Tank gauging is used on large storage tanks in refineries, fuel depots, pipelines, airports, and storage terminals. Storage tanks usually come in four basic designs: Cylindrical fixed roof tanks, cylindrical floating roof tanks and pressurized tanks of either spherical or horizontal cylinder design. There are tank gauges available for all these tank types.

### 1.1 Tank gauging is a system science

The concept of tank gauging involves much more than just the precision instruments on the tank. Tank gauging requires reliable data communication over large field bus networks, often both wired and wireless. The communication solutions often need arrangement for redundancy in the field buses, the data concentrators, the network components and the network servers. Tank gauging systems must also be able to calculate product volumes and mass according to the industry standards. The tank gauging software/information system must perform



# 1 - What is tank gauging?

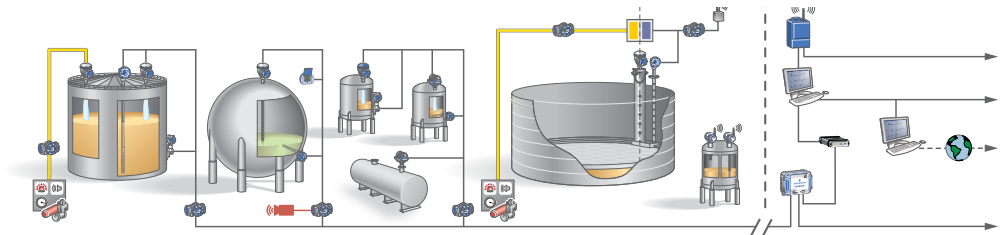

Figure 1.1 : Tank gauging involves a substantial number of interdependent devices and functions.

many different functions spanning from operator interface, batch handling, reporting, alarm functions, connectivity to host systems and much more. It is a system engineering science across many areas of technology.

## 1.2 Where is tank gauging used?

Tank gauging is needed wherever liquids are stored in large tanks. Such storage tanks are found in:

- Refineries
- Petrochemical industry
- Distribution terminals
- Pipeline terminals
- Fuel depots
- Air fueling storage at airports
- Chemical storage

Storage tanks are often placed in clusters or tank farms. The tanks are atmospheric, pressurized or cryogenic.

Atmospheric tanks are vertical cylinders with various roof designs. Most common are:

- Fixed roof tanks, either cone roof or dome roof tanks.
- Floating roof tanks with various designs.

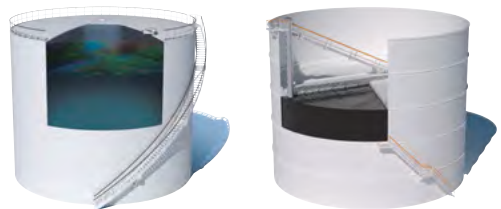

Figure 1.2: Fixed roof and floating roof tanks.

In a fixed roof tank there is a vapor space between the liquid surface and the external roof.

In a floating roof tank the liquid surface is covered by either an internal or an external floating roof. There are many different designs of floating roofs depending on the service, the liquid and the size of the tank. It is common that floating roof tanks have one or more still-pipes that go from the bottom of the tank, through an opening in the floating roof to the top of the tank. This still-pipe is used to access the liquid for sampling, hand level gauging, hand temperature measurement and automatic tank gauging. With a good Automatic Tank Gauge (ATG) design, all these things can be performed in one still pipe.



# 1 - What is tank gauging?

Pressurized tanks are often of spherical or horizontal cylinder design.

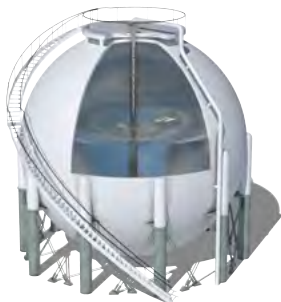

Figure 1.3: Pressurized tanks normally require automatic tank gauging in a still-pipe.

Hand gauging cannot be performed on pressurized tanks. For high accuracy automatic tank gauging a still-pipe inside the tank is normally required.

In cryogenic tanks, automatic tank gauges are often of the same design as for pressurized tanks.



Photo by courtesy of Center for Liquefied Natural Gas

1.4: Cryogenic tank storing LNG at  $-162^{\circ}\text{C}$ .

The methods for proper automatic tank gauging are described in various engineering standards. The most commonly applied standards are the [Manual of Petroleum Measurement Standards \(MPMS\)](#) issued by the American Petroleum Institute (API).

## 1.3 The purpose of tank gauging

The information from a tank gauging system is used for many different purposes. The most common are:

- Oil movement and operations
- Inventory control
- Custody transfer
- Loss control and mass balance
- Volume reconciliation
- Overfill prevention
- Leak detection

### 1.3.1 Oil movement and operations

The operation of a tank farm relies heavily on information regarding the situation in the tank farm. To operate the tank farm safely and efficiently it is important to know exactly what is going on inside the tanks. The tank gauging system must at any given time provide instant information about:

- How much liquid is in the tank
- How much available room is left in the tank
- At what level rate the tank is being filled/ discharged
- When the tank will reach a dangerously high level
- When the tank will become empty at a given pump rate
- How long a given batch transfer will take

The operation will also require that the tank gauging system gives alerts and alarms before any preset level or dangerous high tank level is reached.

Oil movement and operations depend on reliable and readily available tank information. A loss of tank gauging data will seriously interrupt time critical operations and product transfers which may lead to unplanned shut downs.

# 1 - What is tank gauging?

## 1.3.2 Inventory control

A tank farm stores valuable assets, and owners of the assets will require very accurate assessments of their value.

The tank gauging system should be able to provide high accuracy inventory reports at given intervals or instantly if so required. Automatic measurement of free water at the bottom of the tank may also be required for accurate inventory assessment. The tank inventory figures are essential for financial accounting purposes and are often used for fiscal and customs reporting. The system should be able to calculate net volumes and mass according to the rules set forth by industry standards organizations such as API and others.

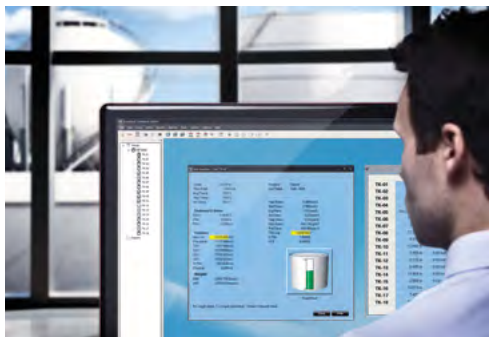

Figure 1.5: Inventory management calculations.

## 1.3.3 Custody transfer

When buying and selling large volumes of liquids, tank gauging data serves as the main input for establishing correct invoicing and taxation. Certified tank gauging can provide more accurate transfer assessments compared with metering when performing large transfers such as from a tanker ship to a shore tank. With a certified tank gauging system manual tank surveying can often be omitted.

For legal or fiscal custody transfer, the tank gauging system must be certified by international authorities, mainly the International Organization of Legal Metrology (OIML). The system may also be required to have approvals from local metrology entities such as PTB, NMI, LNE or other national institutes.

Custody transfer requires the highest possible accuracy of the tank gauging system. The OIML standard R 85:2008 defines the requirements for tank gauges used for custody transfer.

## 1.3.4 Loss control and mass balance

The financial impact of refinery losses is of great importance. Achieving a high quality mass balance of a refinery is the method by which losses are estimated. It is important to distinguish between real losses and apparent losses stemming from measurement errors.

The refinery loss is defined as:

$$\text{Loss} = \text{inputs} - \text{outputs} - \text{current inventory} + \text{previous inventory} - \text{fuel}$$

For loss control purposes the highest possible accuracy of inventory measurement is required. Hence the quality and performance of the tank gauging system is of utmost importance in the area of loss control and mass balance.

## 1.3.5 Overfill prevention

A tank overfill can have disastrous consequences. A spill can cause explosions and fire that can spread to all tanks in the tank farm and to the surrounding area. Since the tanks contain huge amounts of stored energy, a fire can have far-reaching consequences.

Fires caused by overfill have rendered legal damages exceeding \$1 billion. From this, and many other perspectives, preventing tank overfill is extremely important.

A spill can happen when the tank operators are unaware of what's going on in the tank farm. This could take place if an undetected fault occurs in the tank gauging components. High level switches could, if not maintained and tested properly, also fail.

Tank gauging devices provide the basic process control layer in the tank farm. Independent high level indicators or level-switches form the next layer of protection. Any undetected failure of these two protection layers can cause a serious accident.



Figure 1.6: Puerto Rico accident in 2009.

This is why the reliability of the tank gauging system and the high level alarm system has to meet the requirements stated by the standards for Functional Safety. More about this subject is explained in Chapter 10.

### 1.3.6 Leak detection

If the tank gauging system is accurate and stable enough it can be used for tank leak detection. When a tank is settled and closed, the tank gauging system can be set to detect small liquid movements. It is recommended that leak detection is based on Net Standard Volume (NSV) rather than just level. By monitoring the NSV, level movements caused by temperature changes can be canceled out. Custody transfer grade accuracy performance of the tank gauging system is required for proper leak detection.

### 1.3.7 Volume reconciliation

Tank farm operations need to accurately manage transactions and reconcile transfers versus physical inventory. Every company is accountable; reconciliation and error reporting provide the auditing and traceability that is often required. The tank gauging system will allow the immediate data acquisition and response required for accurate daily accounting and reconciliation.

The performance of flow meters can be monitored when transfer data from the meters are compared with batch reports from the tank gauging system.

# 2

## Tank gauging technologies

| Topic                                    | Page |
|--|------|
| 2.1 Hand gauging_____                    | 8    |
| 2.2 Float gauges_____                    | 9    |
| 2.3 Servo gauges_____                    | 9    |
| 2.4 Radar gauges_____                    | 10   |
| 2.5 Different types of radar gauges_____ | 11   |
| 2.5.1 Process radar level gauges_____    | 11   |
| 2.5.2 Tank gauging radar gauges_____     | 11   |
| 2.6 Radar frequency selection_____       | 13   |
| 2.7 Pressurized tanks_____               | 14   |

# 2. Tank gauging technologies

In addition to manual hand gauging using a tape measure, various automatic tank gauges have developed over time. Most mechanical devices are in contact with the liquid. Modern electronic tank gauges are non-contacting and have no moving parts.

### 2.1 Hand gauging

Hand gauging can be performed on most atmospheric tanks. A specially designed measurement tape is used for this purpose. These are normally made of stainless steel with a weight at the end of the tape graded in millimeters or fractions of inches. The tape is used to measure ullage or innage (liquid level).



Figure 2.1: Hand dipping tape.



Figure 2.2: Hand gauging with a dipping tape.

The ullage is the distance from the reference point of the tank down to the liquid surface. The tank level is then calculated by taking the reference height minus the measured ullage. Ullage measurements are often used on heavier liquids like black oils and crude oil.

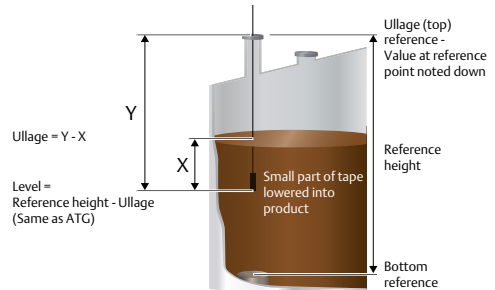

Figure 2.3: Manual ullage measurement definitions.

Direct level measurement (innage) can also be carried out with a hand tape. This method is used on clean liquids since the tape will be submerged into the full height of the tank. When gauging clean products with a tape an indication paste is used to make the surface cut visible.

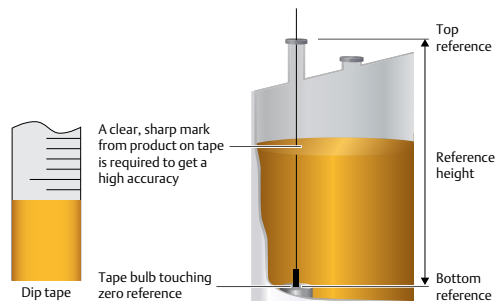

Figure 2.4: Manual level measurement definitions.

For proper and accurate hand gauging, a high quality, newly calibrated tape is required. On heated tanks it may be necessary to calculate the thermal expansion of the tape to obtain good measurement accuracy.

The API standard MPMS Chapter 3.1A describes how proper manual tank gauging is performed.

### 2.2 Float gauges

Automatic tank gauges started to appear in the 1930's. One of the early designs of tank gauges was the float gauge. In this design, a large float inside the tank is connected to a metallic tape. The tape is connected to a spring motor and a mechanical numeric indicator at the lower end of the outside of the tank through a pulley system. No external power is required for a float gauge, the movement of the liquid level powers the whole mechanism.

For remote monitoring the float gauge may be equipped with a transmitter. The transmitter sends the tank level values through signal cables to the control room.

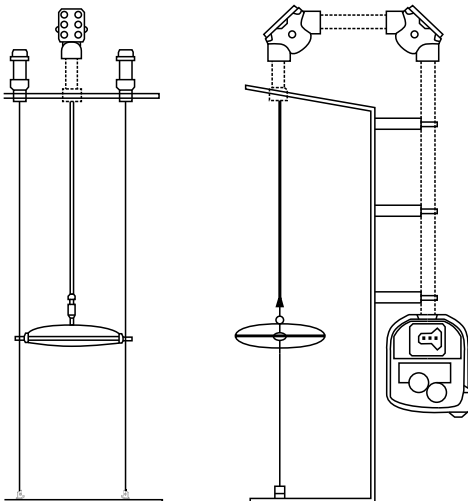

Figure 2.5: The float and tape gauge was introduced around 1940.

The accuracy performance of a float gauge is often low. There are plenty of error sources such as buoyancy differences, dead-band, back-lash and hysteresis in the mechanisms. If anything goes wrong with the float, the tape or the guide wires, it is necessary to carry out service work inside the tank. No gauging can be done with the float gauge while waiting for a repair.

The float gauge is a relatively simple device but has many moving parts that will require maintenance and repair over its lifetime.

### 2.3 Servo gauges

In the 1950's, development in mechanics and electronics led to the servo gauge. With this gauge type, the float is replaced by a small displacer. The displacer has buoyancy but does not float on the liquid. The displacer needs to be suspended by a thin wire which is connected to the servo gauge on top of the tank. A weighing system in the servo gauge senses the tension in the wire, signals from the weighing mechanism control an electric motor in the servo unit and make the displacer follow the liquid level movements. An electronic transmitter sends the level information over field buses to the readout in the control room.

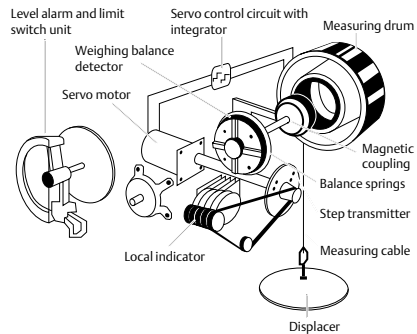

Figure 2.6: Servo gauge.

To keep the displacer from drifting in the tank, a still pipe is needed wherever a servo gauge is installed. This is also required in fixed roof tanks.

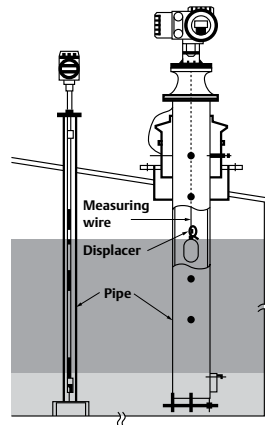

Figure 2.7: Servo gauge and temperature sensor measuring inside still-pipes.



## 2 - Tank gauging technologies

The servo gauge generally performs better than a float gauge. A newly calibrated servo gauge can meet custody transfer accuracy requirements. However, the servo gauge has many moving parts and the displacer and the wire are in contact with the tank liquid. Hence servo gauges need attention in the form of calibration, routine maintenance and repair.

### Servo gauges used for density and water measurement

Some servo manufacturers claim that the unit may be used for purposes other than level gauging. The servo can be used to measure liquid density and water bottom levels, but in both cases the level gauging is inhibited while the servo gauge performs a displacer dip into the product. By measuring the wire tension it is possible to measure the liquid density at various levels in the tank. When water bottom detection is carried out, the displacer is lowered until it hits the free water level at the tank bottom. Both these actions can create dirt build up on the wire, the displacer and the wire drum, creating a maintenance problem over time. The most significant drawback is the lack of level gauging during these dipping exercises. It should also be noted that density measurement with a servo gauge is not recognized by any engineering/ gauging standard.

Today, both float gauges and servo gauges are being replaced by modern tank gauges based on radar technology.

## 2.4 Radar gauges

The first radar tank gauges were developed in the mid 1970's (radar is also referred to as microwaves). The early versions were made for installations on seagoing tankers. Radar technology quickly gained popularity and has since then basically been the only level gauging technology of choice for any large tanker ship.



Figure 2.8: Radar level measurement was introduced for marine applications by Saab in 1976.

In the early 1980's, radar tank gauges were further developed to fit shore based storage tanks. Radar technology rapidly gained market share and is today generally the first choice in any tank gauging project. Since the 1980's, many different radar gauges have been marketed for tank gauging and other level applications. Today, there is a large supply of radar instruments on the market effectively replacing mechanical, ultra sound and capacitance level sensors due to their inherent user benefits.

A radar level gauge has no moving parts and requires no regular maintenance. Radar devices require no direct contact with the liquid. This makes it possible to use a radar gauge on a wide variety of liquids from heated heavy asphalt to cryogenic liquefied gases like Liquefied Natural Gas (LNG).

A good radar tank gauge can easily provide reliable gauging for over thirty years.



Figure 2.9: First high precision radar gauge installed in 1985 on a refinery tank.

If the radar is designed correctly it requires no recalibration after the first adjustment on the tank.





Figure 2.10: Modern radar level gauge on a fixed roof tank.

### 2.5 Different types of radar gauges

There are many radar level gauges on the market. Several are made for process applications where high accuracy and stability are not the primary requirements. Unit cost and other considerations related to these applications are more important.

#### 2.5.1 Process radar level gauges

Process radar devices are made for many different applications in the process industry. High pressure and high temperature combined with strong tank agitation are common challenges for process radar installations. Under these conditions, high level accuracy is not the primary focus. Other qualities such as high reliability and low maintenance are more important. Pulse radar is the dominant technology in most process radar transmitters. Pulse radar provides low cost, low power and reliable gauging under tough conditions. Process radar transmitters are in general 2-wire units driven by a 4-20 mA loop bus powered, or battery powered wireless. They are either of free space propagation type or guided wave. The free space radar transmitters have a horn, a lens or parabolic antenna. The guided wave type has a solid or flexible antenna protruding into the tank.

There is a wide spectrum of process radar devices, and manufacturers in the market serve different market segments such as the chemical industry, oil and gas and the food and beverage industry.

Currently, pulse technology based radar transmitters are less accurate than FMCW based transmitters used for tank gauging applications.



Figure 2.11: Non-contacting radar level transmitter and guided wave radar level transmitter for process applications.

#### 2.5.2 Tank gauging radar gauges

To meet the high performance requirements of custody transfer accuracy in tank gauging applications, radar devices typically use the Frequency Modulated Continuous Wave (FMCW) signal processing method. The FMCW method sometimes goes under the name “Synthesized Pulse”.

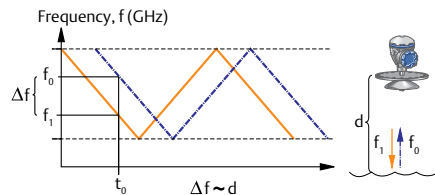

Figure 2.12: The FMCW method.

FMCW is capable of delivering an instrument level gauging accuracy of better than a millimeter over a 50+ meter range.

Since its birth in the 1970's, the FMCW based radar tank gauge has developed rapidly. Several generations of radar tank gauges have been released. The latest design has been miniaturized to the extent that two radar units can share the same small enclosure and deliver reliability and accuracy never seen before. At the same time, power requirements have been reduced to the point that radar tank gauges can be made totally intrinsically safe and require only a 2 wire bus for power and communication.

## 2 - Tank gauging technologies

FMCW is required to make a radar tank gauge accurate, but this is not enough on its own. Precision radar gauges must also have specially designed microwave antennas to be able to deliver both the instrument accuracy and installed accuracy required by custody transfer standards.

One important property of radar antennas is that they should be designed in such a way that any condensation will quickly drip off. Therefore, antennas inside tanks require sloping surfaces to avoid accumulation of condensate liquids.



Figure 2.13: Antenna design with no horizontal surfaces, according to the American Petroleum Institute Standard (API ch. 3.1B, ed. 1)

There are three main types of applications for radar tank gauges:

- Fixed roof tank installation
- Floating roof tank installation on a still pipe
- Installation on tanks with liquefied gases, pressurized or cryogenic

A radar tank gauge should be able to deliver highest accuracy when mounted on existing tank openings. On a fixed roof tank, the openings suitable for tank gauging are normally found on the roof close to the tank wall.



Figure 2.14: Fixed roof tank openings.

This position is ideal due to stability provided by the tank wall and a minimum of roof flexing as a result. A radar tank gauge must be able to deliver highest accuracy even when placed close to the tank wall. Antennas with a narrow microwave beam are most suitable for such tank locations in close proximity to the wall. The larger the antenna, the narrower the microwave beam becomes.

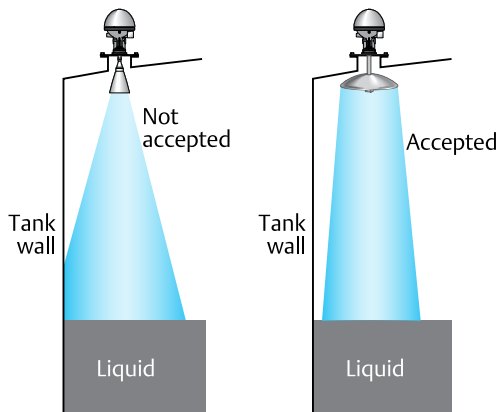

Figure 2.15: Radars with wide beam (small antenna) and narrow beam (large antenna).

On a floating roof tank, the still-pipe is located where any liquid level gauging takes place since the rest of the liquid surface is covered by the floating roof. A radar tank gauge antenna for still-pipes must be designed so that existing still-pipes of various sizes and designs can be used. The still-pipe must have slots or holes to allow good liquid mixing between the inside and the outside of the pipe. If no holes or slots are present it is likely that the liquid level inside the pipe will be different from the rest of the tank. If the pipe is filled from the bottom, heavier product will then accumulate in the pipe. The slots or holes prevent this.

A radar tank gauge for still-pipe applications must have the ability to cope with a still pipe with large slots/holes and yet deliver high accuracy. It must also perform with the highest accuracy even if the pipe has rust and dirt build-up on the inside.

In addition, a still-pipe antenna must be made so that the still-pipe can be accessed for other tasks like sampling and hand gauging.



Figure 2.16: Low loss mode radar measurement can be used to virtually eliminate measurement degradation in old still-pipes.

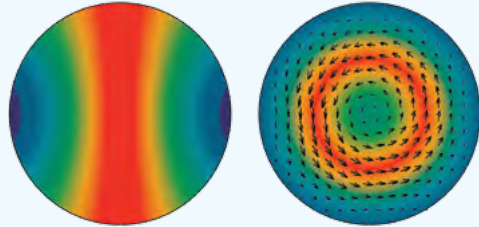

Figure 2.17: Low loss H01 mode visualized.

### Using a still-pipe as a waveguide

Tubular shaped waveguides supporting the so called H01 mode are capable of providing an attenuation of just a few decibels per kilometer. Such pipe shaped waveguides have been tested to act as telecommunication channels across nations. The same low loss H01 propagation mode has successfully been utilized in radar tank gauging applications for many years.

Still-pipes in normal storage tanks are tubular, often in sizes between 5 to 12 in. or 125 to 300 mm in diameter. These pipes can work as wave guides for radar tank gauging in the 10-11 GHz frequency range. A waveguide with holes and slots in combination with dirt build-up and weld residue between pipe sections will generate microwave losses and make the still pipe unsuitable for tank gauging. However, using the low loss mode of the H01 propagation, these slot/hole related problems are virtually eliminated. It is proven that still pipes with more than 30 years of crude oil service will work perfectly as a waveguide for accurate radar tank gauging provided that the low loss H01 is used.



Figure 2.18: Hand dip access in a still-pipe.

important to select the optimal antenna design and the right microwave frequency. When using still pipes as waveguides it turns out that frequencies in the X-band are optimal. Fixed roof storage tanks without still pipes often have tank apertures in sizes 200 to 600 mm (8 to 24 in.) in diameter. Suitable antennas for such openings are those that can handle heavy water condensation and dirt build-up. Under these conditions horn, cone or parabolic antenna design has proven to work very well, especially since they can be designed with drip-off surfaces. Such antennas at this size range have an excellent track record when used in frequency ranges between 9-10 GHz (X-band).

## 2.6 Radar frequency selection

For tank gauging applications, the reliability of the gauging and the accuracy performance are the primary qualities. To meet the requirements it is

Higher frequencies are used in process radar gauges to be able to fit smaller antennas in narrow tank gauge openings. However small antennas and higher frequencies tend to increase sensitivity to condensation and dirt build-up.

### 2.7 Pressurized tanks

Special properties are required for a microwave antenna used for tank gauging in pressurized tanks:

- The antenna arrangement must be able to withstand the tank pressure.
- It should have a shut-off valve for protection and to meet safety requirements.
- It should have the ability to compensate for high-density tank atmospheres and any effect this has on the microwave propagation speed.
- It should be possible to verify the performance of the gauge during normal tank operations.

There are solutions to meet all these criteria with a good gauge and antenna design. See [chapter 7](#) for more about radar gauging on pressurized tanks.

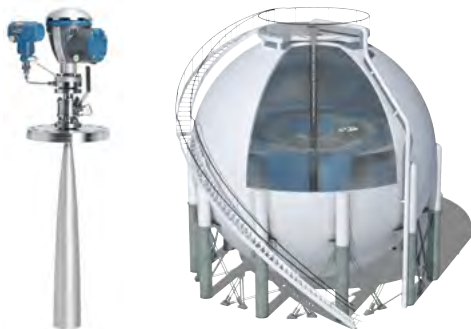

*Figure 2.19: Radar gauge sensor including heavy atmosphere compensation in an LPG tank.*

# 3

## Engineering standards and approvals

| Topic   | Page |
|---|------|
| 3.1 American Petroleum Institute (API) standards          | 17   |
| 3.1.1 Chapter 3.1A and 3.1B                               | 18   |
| 3.1.2 Chapter 3.3: Level measurement in pressurized tanks | 20   |
| 3.1.3 Chapter 3.6: Hybrid tank gauging system             | 21   |
| 3.1.4 Chapter 7: Temperature determination                | 22   |
| 3.2 ISO standards   | 22   |
| 3.3 OIML  | 23   |
| 3.4 National metrological institutes                      | 24   |
| 3.4.1 Nederlands Meetinstituut (NMI)                      | 24   |
| 3.4.2 Physikalisch-Technische Bundesanstalt (PTB)         | 25   |
| 3.4.3 Technical Research Institute of Sweden (SP)         | 25   |
| 3.4.4 Other national institutes                           | 25   |

### 3. Engineering standards and approvals



There are a number of international standards that are relevant for tank gauging. The main purpose of these standards is to serve as guidelines for both users and manufacturers of tank gauging equipment. The members of the working groups behind the development of these documents are in most cases experienced users from the petroleum industry or manufacturers with considerable tank gauging knowledge. It is important that the working groups have a good balance between users and manufacturers, to avoid standards becoming biased in any direction. The present trend is to avoid technology specific standards as much as possible, and specify the requirements on equipment for a certain application. This leaves the door open for any technology to conform, if it can be proved that it fulfils the requirements.

To prove compliance to a standard is however not always easy, since there must be an independent authority/body available that has the knowledge and resources to test a tank gauging system. ISO (International Organization for Standardization) and API (American Petroleum Institute) are responsible for the most important standards within tank gauging, but do not have their own test organization and are not organized as typical test institutes.

Instead it is the national metrological authorities in a country who should have this expertise. Depending on how custody transfer based on tank gauging equipment has been implemented in their country,

they have (to a varying degree) the necessary experience, skills and resources. Therefore, in countries where there are legal requirements for tank gauging equipment, there should also be a department within a metrological organization which handles the legal aspects of tank gauging equipment. Typically it works like this:

1. The government is responsible for the law (the legal requirements on tank gauging), and they issue an accreditation to a national test institute through an accreditation body.



2. The test institute must show the accreditation body that they have the skill and expertise to perform the testing, and they must also define a test procedure.



3. After approval from the accreditation body, the test institute is granted the right to perform testing and can then issue a test report. If the test report conforms to the legal custody transfer requirements, an approval can be issued.

Fortunately, the different national institutes in the world that perform testing are cooperating within an organization named OIML (International Organization of Legal Metrology). In this organization a number of test procedures are defined, and there is a special procedure defined for tank gauging equipment called [R 85 \(Recommendation 85\)](#).

Since most countries that have defined requirements for legal custody transfer are members of OIML, the test procedure for having national approval is basically the same in each OIML country, and complies with R 85. There may be some minor differences in the requirements from one country to another, but in principle a country that is a member of OIML should not adopt any other requirements than those prescribed by R 85.

A tank gauging system that has been tested by an accredited OIML R 85 institute in one country, will therefore not need to repeat the same test in another. However, it cannot be assumed that there

## 3 - Engineering standards and approvals

will be an automatic approval in each new country, since the original R 85 test report will often be subject to a thorough examination to check that the R 85 procedure has been followed as intended.

Since many requirements on level gauges for tank gauging in OIML R 85 have been harmonized with the requirements defined in both the ISO and API standards, it will in most cases mean that a level gauge that fulfils the testing criteria according to OIML R 85 also fulfils the requirements according to ISO and API. It should be noted however, that the OIML R 85 only covers the testing of the level gauge functions. Product temperature measurements or density measurements are not covered by OIML so far, see [section 3.3](#).



Figure 3.1: Still-pipe in an open floating roof crude oil tank.

Another aspect of the standards should also be noted. If an accident such as an overfill of a tank (or in the worst case a fire with casualties) occurs at a petroleum plant, it will probably result in a lawsuit and/or criminal prosecution. In such legal proceedings the status of the whole installation of the level gauge system is likely to be scrutinized. One question then becomes very important: “Is the level gauge system installed and operable to best engineering practice?”

If not, and the level gauge system or installation is in a bad condition, it is probable that the owner of the plant could receive serious fines, have to pay huge damages, or even face imprisonment. If the owner, on the other hand, can show that the equipment or installation conforms to a standard with good

reputation like the API or ISO standards, it may be difficult to prove that the status of the equipment is not according to “good engineering practice”. In particular, the guidelines in API Manual of Petroleum Measurement Standards (MPMS) chapter 3.1A and chapter 3.1B are important in this respect, since they include several guidelines which could be said to define “good engineering practice”, see following example:

### Example 3.1: Good engineering practice

API MPMS chapter 3.1 A recommends how a still-pipe in a floating roof tank should be designed, and especially what minimum hole size is needed to ensure proper product flow from outside the pipe to the inside. It is obvious that holes that are too small, (or no holes at all) could cause an overfill since the level gauge mounted on the still-pipe in this case would indicate a level that is too low, because the level outside the pipe will be higher. On the other hand, the user does not want to have an excessive hole size since this would increase product evaporation which could conflict with environmental regulations. By complying with the recommendation in API MPMS chapter 3.1A, the owner would be following recommendations issued by the most knowledgeable people in the petroleum industry.

### 3.1 American Petroleum Institute (API) standards

The API standards are well known by most people in the petroleum industry. One important characteristic of the API standards is that they provide very useful experience based facts about daily tank gauging problems and how to solve them. They also summarize know-how from practical investigations which have been performed by research departments at major oil companies. Specifically for tank gauging there are some important API standards in MPMS such as:

- **Chapter 3.1A** Standard Practice for the Manual Gauging of Petroleum and Petroleum Products
- **Chapter 3.1B** Standard Practice for Level Measurement of Liquid Hydrocarbons in Stationary Tanks by Automatic Tank Gauging



The logo for the American Petroleum Institute (API) consists of the letters 'API' in a large, bold, red, sans-serif font. The letters are closely spaced and have a slight shadow effect.

The American Petroleum Institute (API) was established in New York City 1919, following a momentum build towards forming a national association to represent the oil and gas industry in the postwar years.

Today, API is based in Washington D. C. and it is the largest U.S trade association for the oil and natural gas industry. It represents approximately 650 petroleum industry corporations involved in production, refinement and distribution among other areas.

The main function of the API is speaking for the oil and natural gas industry in order to influence public policy in support of the industry. Its functions include advocacy, negotiation, lobbying, research, education and certification of industry standards.

- **Chapter 3.3** Standard Practice for Level Measurement of Liquid Hydrocarbons in Stationary Pressurized Storage Tanks by Automatic Tank Gauging
- **Chapter 3.6** Measurement of Liquid Hydrocarbons by Hybrid Tank Measurement Systems
- **Chapter 7** Temperature Determination
- **Chapter 7.3** Temperature Determination – Fixed Automatic Tank Temperature Systems
- **API 2350** [Overfill Protection for Storage Tanks in Petroleum Facilities](#)

These standards are briefly described below.

### 3.1.1 Chapter 3.1A and 3.1B

The API MPMS chapter 3.1A is related to how to perform manual measurements according to best engineering practice. Since the manual measurement on the tank is the reference for automatic measurement with level gauges, it is of utmost importance that manual gauging is performed correctly. Chapter 3.1A includes detailed information on how a manual measurement should be performed and also how it should not be performed. This procedure may seem very simple at first glance, but it

is surprising how often a discrepancy between a value taken by hand dip and a value from an automatic level gauge is caused by an inaccurate hand dip. The reason may be that poor equipment such as inaccurate/non-calibrated hand dip tapes were used, temperature corrections of the tape were not made, the hand dip was carried out on a moving/turbulent surface, or the person performing the hand dip was careless etc.

Another common reason for hand dipping discrepancy is the mechanical properties and instability of the tank. The influence of mechanical instability can be explained as follows: The level gauge measures the distance from its reference point down to the liquid surface, and calculates the level by subtracting the measured distance (ullage) from the reference height (the distance from the gauge hatch reference down to the datum plate, see [chapter 2 figure 2.1](#)).

The person who performs the hand dip measures the distance from the datum plate up to the mark the product makes on the tape, i.e. if the reference height varies due to mechanical or thermal stress there will be a discrepancy. How much the reference height varies depends on the actual tank type and the design of the tank. In API MPMS chapter 3.1A (and also in chapter 3.1B) there is valuable information on how to design tanks with a minimum variation of the reference height. Some important basic guidelines can be mentioned:



### 3 - Engineering standards and approvals

#### Tank with still-pipe:

- If the tank has a still-pipe it is important that it is attached to the tank bottom correctly and that it is guided only at the top, see figure 3.2.

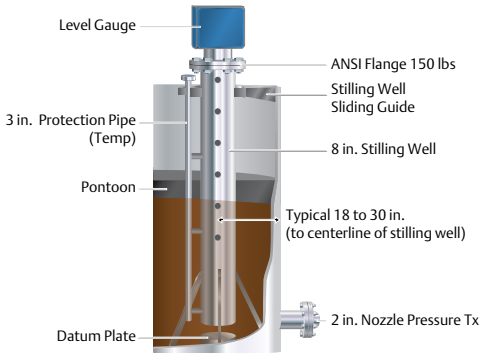

Figure 3.2: Still-pipe attached to the tank bottom.

- When attached to the wall, the bulging effect of the tank wall due to heavy static pressure from the liquid should not cause the still-pipe to move vertically. A hinge design as in figure 3.3 should prevent this.

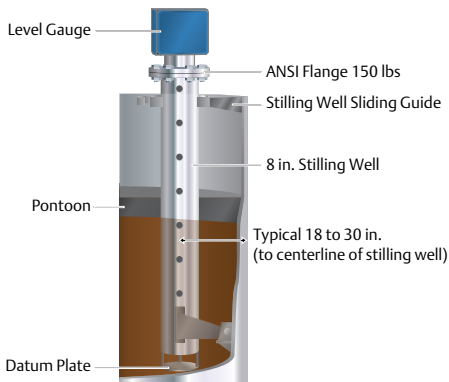

Figure 3.3: Still-pipe attached to the tank wall.

- The datum plate (the hand dip reference plate) should be attached to the still-pipe and not installed on the bottom of the tank unless the still-pipe stands directly on the tank bottom.

#### Tank with fixed roof, no still-pipe:

- To avoid movements between the level gauge reference point and the gauge hatch, the level gauge should be installed close to the gauge hatch.
- When the level gauge is installed on a manway on the roof, flexing of the roof where the level gauge is located should be minimized. Best practice is to install the level gauge “fairly” close to the tank wall where the roof is most stable. (The meaning of “fairly” depends on the level gauge type, see relevant level gauge installation information.)

Some of the reference height variations can also be compensated for in a modern level gauge. The criteria for using this option is that the variation is predictable. Bulging of the tank wall is one example, since it is related only to the static pressure on the tank wall and therefore predictable. If the reference height is measured at a number of different product levels, it is possible to program the change into the level gauge and compensate the level value for the reference height variation. Another predictable variation is the thermal influence on the tank wall or still-pipe. By using the temperature information from a multi-spot temperature sensor, the level gauge can compensate for the expansion/contraction caused by temperature changes. For a fixed roof tank, this compensation calculation depends on both the ambient temperature and liquid temperature. Chapter 3.1A describes how this should be taken into account.

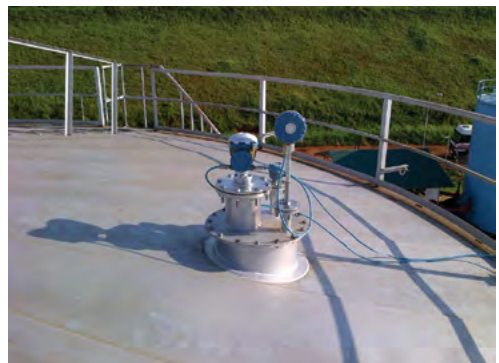

Figure 3.4: Manways are normally located near the tank wall which provides mechanical stability.

Chapter 3.1A lacks a more exact description regarding how to handle the hand dip tape and how to make tape corrections. Some users measure ullage (the distance from a reference in the dip hatch to the liquid surface) instead of level. This is common for heavy products in order to avoid the whole tape being coated with product. Hand dipping a full bitumen tank in cold winter weather by lowering the tape all the way down to the bottom will make the tape unusable for the future.

When making a hand dip in heated tanks it is very important to make a temperature correction of the tape. An example:

- A hand dip tape typically has a thermal expansion coefficient of 12 ppm / °C, and is calibrated at 20°C.
- In a bitumen tank with temperature 220 °C and at 20 m distance the tape will be:  $(220-20) \times 12 \times 10^{-6} \times 20000 = 48$  mm longer.
- The tape will consequently show an error of 48 mm at 20 m distance.

It is clear that in the case above temperature correction is necessary. This is also the case in heated tanks with lower temperatures like fuel oil etc. where temperature correction is necessary to get a reference accuracy in the range of a few millimeters.

Another method of hand dipping used by some is to attach a metal bar at the hand dip tape and position the tape by placing the bar on top of the hand dip hatch and only dip the lowest end of the tape into the liquid. After subtracting the liquid cut on the tape from the value on the tape to which the bar was attached, it is possible to get a very exact reading. This is an ullage measuring method, and reference height changes will not influence the reading except for any variation in the level gauge reference position compared to the position of the gauge hatch.

API MPMS chapter 3.1A and also 3.1B strongly recommends that the user measures the reference height at the same time as the liquid level hand dip is made. This is a very straightforward method, and it will immediately tell the user if any discrepancy is related to the level gauge or to the mechanical instability of the tank.

In API MPMS chapter 3.1B, the focus is on automatic tank gauging equipment. The chapter does not specify any particular preference for any technology, but it is very clear that there are very few technologies that can meet the custody transfer requirements of 1 mm (0.04 in.) accuracy under laboratory conditions over the whole temperature range.

Chapter 3.1B also specifies a very relaxed accuracy requirement when the level gauge system is used for inventory purposes only. The requirement is defined as low as 25 mm (1 in.). It is unlikely that a user would purchase a level gauge system with such a low performance, so it is probable that this figure is set to allow old systems to fall in the category of “best engineering practice” in a legal dispute, and they would therefore not be in immediate need for exchange to more modern equipment.

The level gauge system is generally not only used for operations, custody transfer and inventory purposes, but also for mass balance, loss control and in some cases leak alarm purposes. Chapter 3.1B does not address the requirements of these latter purposes at all, however in modern tank gauging it could be noted that many users have similar requirements for these as for custody transfer purposes. The requirements do however become more complicated since the requirements for mass balance and loss control are based on mass precision, and level accuracy is in these cases only one parameter in the equation.

#### 3.1.2 Chapter 3.3: Level measurement in pressurized tanks

The standards in Chapter 3.3 deal with level measurement in pressurized tanks. It describes the special safety precautions required for pressurized LPG tanks and how an installation according to best practice may be achieved.

A special circumstance with a pressurized tank is that the normal reference measurement with a manual hand dip cannot be used. Instead the standard describes some indirect reference methods; one for servo based, and one for radar based level gauges. This means that in this case, the rule of avoiding technology specific solutions has not been followed.

Both the described reference methods may be questionable from a theoretical metrological point of view, since the traceability to a national standard is not entirely straightforward. However, there are no better verification methods for this application, and the metrological authorities have in general accepted the limitations of the reference methods.

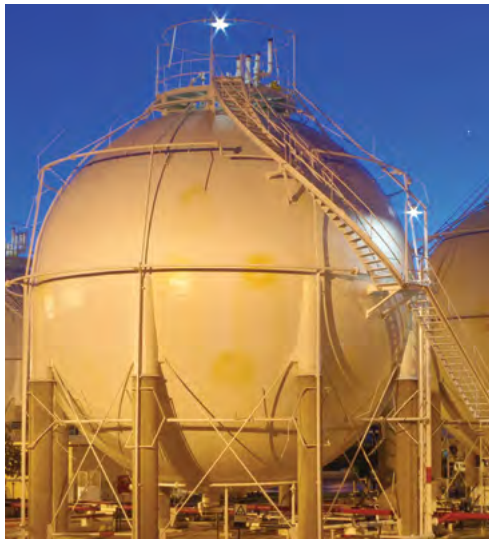

Figure 3.5: Level measurement in pressurized tanks cannot be done by hand gauging, leading to technology specific recommendations for servo based and radar based level gauging.

Since LPG usually has a lower economic value compared to refined oil products, user requirements are generally not that strict. Often the accuracy achieved by mass flow measurements is regarded as sufficient. Transactions of LPG based products based on legal custody transfer are therefore not very common.

Much of chapter 3.3 instead focuses on performance requirements to obtain a safe and reliable measurement in LPG tanks, and the accuracy figures mentioned are very much based on the metrological uncertainty in the reference measurement, where hand dip not is an alternative. Despite this, chapter 3.3 provides valuable information on best practices for installing and putting a level gauge system for LPG in operation.

### 3.1.3 Chapter 3.6: Hybrid tank gauging system

The name “hybrid tank gauging system” comes from the fact that it is a combination of a traditional tank gauging system and a Hydrostatic Tank Gauging (HTG) system. There are two main use cases for a hybrid system where the user is interested in either mass or density (or both).

Most hybrid system users in the petroleum industry are interested in measuring density online since the calculation of transferred volume (Standard Volume) requires measurement of level, temperature and density. The hybrid system makes it possible to avoid manual density measurement on tanks, which is a labor intensive task and is often related to serious measurement errors if not done properly. To be able to calculate density, a hybrid system therefore has one pressure sensor if the tank has atmospheric pressure, and two pressure sensors if the tank is not freely ventilated.

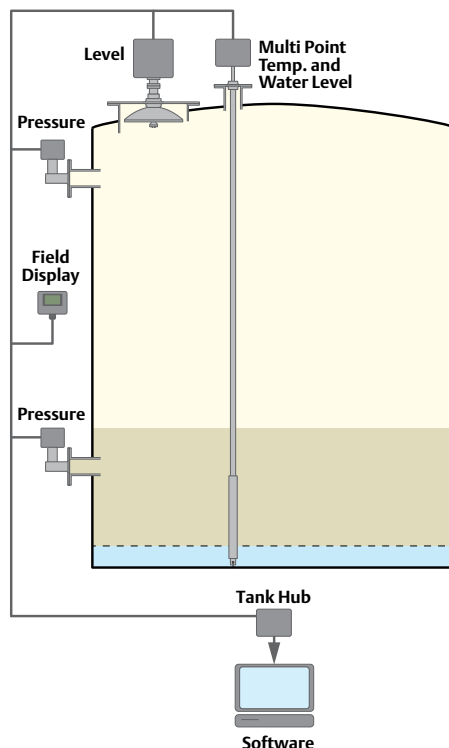

Figure 3.6: Hybrid tank gauging is a combination of a traditional tank gauging system and an HTG system.

In a traditional Hydrostatic Tank Gauging (HTG) system there is one additional pressure sensor and no level gauge system. The product density in the HTG system is calculated from the density between the P1 and P2 sensors only. The density in this range is not representative of the density of the whole tank and the value is therefore normally not usable for custody transfer.

With a hybrid system, the density is calculated by using the liquid column height above the P1 sensor given by the level gauge. In this case a much more accurate density value is received, representing the overall density of the product.

Since most petroleum products are by tradition traded based on standard volume and not mass, the use of a hybrid system (or HTG system) for mass measurement is of very limited use worldwide. There are however some exceptions, for example China, which has for many years used mass based custody transfer. Some installations, mainly for storage of special chemical petroleum products are another exception, but they are in general rare.

Chapter 3.6 is unique in that it not only gives information on best practice for installation of a hybrid system, but it also shows what accuracies can be expected on density and mass. All calculations in a hybrid system and the expected performance will be discussed in chapter 8.

### 3.1.4 Chapter 7: Temperature Determination

API MPMS chapter 7 is now being revised and one important new approach is to divide the different use cases into four subchapters. The previous edition of chapter 7 included many different temperature measuring cases in the same section which was somewhat confusing, so the new approach is an improvement.

Only part 7.3 is finalized today. It describes temperature measurements in tanks for inventory and custody transfer purposes. Section 7.3 gives a lot of important guidance on how a proper installation should be made, how many sensors are required for custody transfer use, and what accuracy on individual temperature elements, electronic conversion units, etc. is required.

Since the accuracy of a modern level gauge today is very high, it is in many cases the temperature

accuracy that is the most critical measurement in order to get a high accuracy of the quantity assessment. The importance of temperature measurement accuracy is described more in chapter 6.

## 3.2 ISO standards

The International Organization for Standardization (ISO) has also developed a number of standards for tank gauging. In the past these standards could be quite different compared to API standards, but during the last 15 years, considerable harmonization between API and ISO has taken place.

This has resulted in standards which have very similar content. As a consequence it was decided to have more direct cooperation between API and ISO, which would reduce the costs for the standards development.

Today ISO issues no new standards in the tank gauging area. Instead ISO takes an active part in the API work of standard revisions and development of new ones. There are however some API standards not yet ready (one example is the remaining sub chapters under API chapter 7) and therefore some ISO standards are still relevant.

The ISO standards are not discussed in detail in this guide, but the list below shows the relevant ISO standards for tank gauging purposes:

- **ISO 4266-1:2002** Petroleum and liquid petroleum products -- Measurement of level and temperature in storage tanks by automatic methods -- Part 1: Measurement of level in atmospheric tanks
- **ISO 4266-2:2002** Petroleum and liquid petroleum products -- Measurement of level and temperature in storage tanks by automatic methods -- Part 2: Measurement of level in marine vessels
- **ISO 4266-3:2002** Petroleum and liquid petroleum products -- Measurement of level and temperature in storage tanks by automatic methods -- Part 3: Measurement of level in pressurized storage tanks (non-refrigerated)

- **ISO 4266-4:2002** Petroleum and liquid petroleum products -- Measurement of level and temperature in storage tanks by automatic methods -- Part 4: Measurement of temperature in atmospheric tanks
- **ISO 4266-5:2002** Petroleum and liquid petroleum products -- Measurement of level and temperature in storage tanks by automatic methods -- Part 5: Measurement of temperature in marine vessels
- **ISO 4266-6:2002** Petroleum and liquid petroleum products -- Measurement of level and temperature in storage tanks by automatic methods -- Part 6: Measurement of temperature in pressurized storage tanks (non-refrigerated)
- **ISO 15169:2003** Petroleum and liquid petroleum products -- Determination of volume, density and mass of the hydrocarbon content of vertical cylindrical tanks by hybrid tank measurement systems

### 3.3 OIML

The most important document from OIML which concerns level gauges is the R 85 recommendation. This document specifies the requirements of a level gauge that should be used for legal custody transfer, how it should be tested for a pattern approval, and what procedures should be followed to put the level gauge in operation on a tank. In addition it describes

a suitable procedure for verifying that the level gauge is in proper condition.

The requirements of the level gauge when used for legal custody transfer are quite high, and today there are very few products that can live up to them. The reason for the high demands is that a level gauge in legal use acts as a third party between a buyer and a seller of large volumes of bulk liquids with high economic value. The measurement device is neutral in this transaction, and there are many corresponding transactions in our daily life which are similar. Some examples which we take for granted are the result from a weighing machine or a gasoline pump, where we don't question the result if we know that it is approved by a metrological office.

Also, the result from the level gauge can often be used for determination of import tax where the government has an interest in the measurement having highest possible precision.

The accuracy requirements in OIML R 85 for having pattern approval is: Maximum Permissible Error (MPE) which may not be larger than  $\pm 1$  mm (0.04 in.) over the intended operating range. In addition this requirement must be fulfilled over the intended temperature range which may be the most severe requirement, since it puts high requirements on the temperature stability of both mechanical components and electronics. The installed accuracy requirement is: MPE may not be larger than  $\pm 4$  mm (0.16 in.), and this figure includes not only errors from the level gauge but also all errors from tank mechanics, thermal stress of the tank etc.

# OIML

The International Organization of Legal Metrology (OIML) is an intergovernmental organization founded in 1955 and based in Paris. It promotes global harmonization of legal metrology procedures that are the base of and facilitate international trade. Harmonizing legal metrology ensures that certification of measuring devices in one country is compatible with certification in another.

OIML has developed guidelines to assist its members in creating appropriate legislation and guidelines on certification concerning metrology. They work closely with other international organizations to ensure compatibility between certifications. OIML does not have the authority to impose solutions on its members, but its recommendations are often used as part of domestic laws.

## 3 - Engineering standards and approvals

The procedure when testing a level gauge against R 85 also includes a number of influence factor tests, like EMC, short power interrupts, stability in communication links, provisions to allow metrological sealing etc. Consequently, a level gauge that passes a pattern approval test according to R 85 will have shown that it has potential to work with high precision on a tank. However it is not sufficient to just pass the pattern approval tests, since the level gauge also needs to conform to the installed accuracy requirements, i.e. the whole mechanical arrangement on the tank must be in good condition. The latter is normally the responsibility of the owner of the tank, but in practice the level gauge manufacturer is often involved by giving guidance and recommendations to the tank owner.

So far OIML has not issued any recommendation on how to measure temperature or density for legal tank gauging purposes. Corresponding ISO and API standards are therefore at present the most important documents in this area. Also the requirements on total volume accuracy is not defined in any OIML recommendation, even though working group activity has been discussed.

### 3.4 National metrological institutes

As mentioned earlier, neither ISO nor API are organized as test laboratories, and therefore they do not have the capability to test a tank gauging system against the requirements in a standard. Since the test procedure is not described in detail in most standards, it will be up to the test institute, who is often the expert in this area, to define the procedure. OIML has for their guidance developed a detailed test procedure for OIML R 85, and it is expected that this procedure will be followed by all institutes. This is a big improvement compared to how it was some 20 years ago, when each country had their own test procedure, which made tested equipment more expensive in each country, and also reduced the number of available models of level gauges.

The procedure to get an approval in a country is much easier today:

1. Use the test report made by a test institute that is approved for OIML R85 testing. This report should state that requirements in R 85 are fulfilled.



2. Send the test report to the national test institute in the country subject to an approval.



3. The test institute in the country subject to approval, may have comments or questions, and it may be necessary to design a special approval plate with the native language etc.



4. When the above is performed, an approval can be issued.

This procedure assumes that the actual country has accepted OIML R 85 as the base for their national requirements. Not all countries have yet become members of OIML, but it is very rare that they will not accept OIML R 85, or have requirements that are not in line with R 85.

Some OIML member countries have been approved for making tests of level gauges according to the R 85 recommendation. Some of the most important are mentioned below (in alphabetical order):

#### 3.4.1 Nederlands Meetinstituut (NMI)

NMI has a long experience in testing level gauge systems used for custody transfer, especially servo based level gauges. They chaired the secretariat for R 85 for many years, and there is a long history of using metrological sealed level gauges in the Netherlands.

### 3.4.2 Physikalisch-Technische Bundesanstalt (PTB)

Germany also has a long history of using level gauge systems under legal metrological control, and the approval of equipment has been made by PTB. Some time ago Germany had their own requirement for level gauge systems, but have now adopted R 85 as their national requirement. Germany has also for many years had national requirements on the temperature measuring system in a tank gauging system. Surprisingly, they are alone on this despite the fact that temperature is a very important parameter in the assessment of a transferred quantity. See chapter 6 and [example 6.1](#) for the influence of temperature on volume and mass assessment.

### 3.4.3 Technical Research Institute of Sweden (SP)

SP has also been accredited for the testing of level gauge systems according to OIML R 85. They have a very good reputation for testing advanced radar based level gauge systems, and they use very advanced equipment for testing this type of technology. The total uncertainty in the test equipment they use is less than 0.17 mm (0.0067 in.) over a 30 m (98 ft) measuring range.

### 3.4.4 Other national institutes

*Bundesamt für Eich- und Vermessungswesen (BEV)* in Austria chaired the secretariat for R 85 for a number of years in the past, and have also carried out some testing against OIML R 85 requirements.

*National Institute of Standards and Technology (NIST)* in the USA has recently taken over the secretariat for R 85. Custody transfer under legal metrological control is not well known in the USA currently, however with the presence of API and many major oil companies there is a lot of know-how in the country. The fact that the institutes mentioned above are experts on metrological issues and often have limited knowledge of the practical life for a tank gauging system, has sometimes raised criticism against documents like R 85. With NIST as chairman (and maybe with API involved) this could probably be overcome.





# 4

## Volume and mass assessment

| Topic | Page  |
|-------|---|
| 4.1   | Volume assessment_____28                                |
| 4.1.1 | Total Observed Volume (TOV)_____28                      |
| 4.1.2 | Gross Observed Volume (GOV)_____29                      |
| 4.1.3 | Gross Standard Volume (GSV)_____29                      |
| 4.1.4 | Net Standard Volume (NSV)_____31                        |
| 4.2   | Mass assessment_____31                                  |
| 4.3   | Quantity assessment of liquefied petroleum gases_____31 |



## 4. Volume and mass assessment

Measurement data from a tank gauging system plays an important role for the operation of both refineries and terminals in the petroleum industry. Depending on the type of operation, various calculations are performed which to a high degree have been standardized within the industry.

### 4.1 Volume assessment

Calculation of volumes is central, and this procedure is described in figure 4.1 below. For a more detailed view, see [figure 4.4](#).

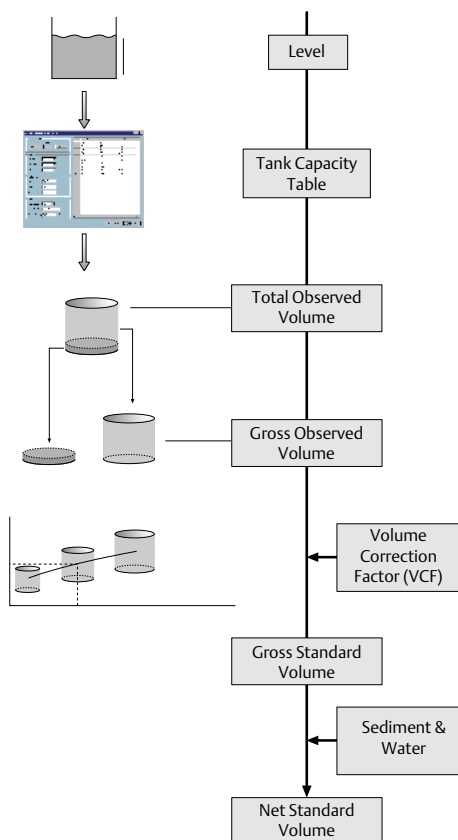

Figure 4.1: Volume calculation flowchart.

#### 4.1.1 Total Observed Volume (TOV)

The measurement value from the level gauge is a value that is calculated within the level gauge. When calculating the value, corrections both for reference height changes due to static mechanical stress and temperature expansion/contraction may have been applied. This corrected level value is entered in what is referred to as a Tank Capacity Table (TCT), also called a Strapping Table. The TCT converts the level value to a volume value normally called Total Observed Volume (TOV). Since the TCT is only valid for certain temperatures, a correction also needs to be applied to allow for tank wall expansion/contraction due to the influence of product temperature and ambient temperature. API has stated that the tank wall temperature for non-insulated tanks should be calculated as:

$$T_{tankwall} = \frac{7}{8} T_{product} + \frac{1}{8} T_{ambient}$$

Measuring the ambient temperature on a tank may however require an expensive ambient meteorological station on each tank, so in many cases this figure is manually entered as a fixed value, since it does not affect the final result very much. The temperature effect from the liquid can however be quite large on the TCT, especially on heated products, or tanks which have ambient temperatures which differ considerably from the calibration temperature of the TCT.

The correction for a TCT due to temperature on a cylindrical carbon steel tank is:

$$VolumeTCT_{corrected} = VolumeTCT \times (1 + \Delta T \times 0.000022)$$

$$where \Delta T = T_{TCT \text{ calibration temp}} - T_{tankwall}$$

Some TCTs also state that a correction due to density should be applied, i.e. this means that the TCT is only valid for a certain product density, and a different density will, due to more or less mechanical stress,

## 4 - Volume and mass assessment

| ENERGY STORAGE COMPANY |                    |                 |             |                    |                 |             |                    |                 |
|------------------------|--------------------|-----------------|-------------|--------------------|-----------------|-------------|--------------------|-----------------|
| LPG TANK NO : 10       |                    |                 |             |                    |                 |             |                    |                 |
| NOV 1994               |                    |                 |             |                    |                 |             |                    |                 |
| Dip<br>[mm]            | Volume<br>[litres] | Incr.<br>[l/mm] | Dip<br>[mm] | Volume<br>[litres] | Incr.<br>[l/mm] | Dip<br>[mm] | Volume<br>[litres] | Incr.<br>[l/mm] |
|                        |                    |                 | 100         | 12,062             | 81.8            | 200         | 19,811             | 87.2            |
|                        |                    |                 | 110         | 12,813             | 75.1            | 210         | 20,705             | 89.4            |
|                        |                    |                 | 120         | 13,488             | 67.4            | 220         | 21,619             | 91.4            |
| 30                     | 7,374              | 45.0            | 130         | 14,190             | 70.3            | 230         | 22,554             | 93.5            |
| 40                     | 7,873              | 49.9            | 140         | 14,920             | 73.0            | 240         | 23,508             | 95.4            |
|                        |                    |                 |             |                    |                 |             |                    |                 |
| 50                     | 8,438              | 56.5            | 150         | 15,675             | 75.5            | 250         | 24,482             | 97.4            |
| 60                     | 9,063              | 62.5            | 160         | 16,456             | 78.0            | 260         | 25,474             | 99.2            |
| 70                     | 9,741              | 67.8            | 170         | 17,260             | 80.5            | 270         | 26,409             | 93.5            |
| 80                     | 10,470             | 72.8            | 180         | 18,088             | 82.8            | 280         | 27,360             | 95.1            |

Figure 4.2: Example of a Tank Capacity Table.

change the values in the TCT. It is unusual to see this correction today, but in case it is required, a modern tank gauging system should have this possibility.

Another correction that should be made applies to floating roof tanks with still-pipes. In a floating roof tank, the roof will occupy a certain volume of the product and it should therefore be subtracted from the value given by the TCT. This correction depends on the weight of the roof and the observed density of the product, where the observed density is the actual density of the product at the temperature when the correction is made.

### 4.1.2 Gross Observed Volume (GOV)

The next calculation step is Gross Observed Volume, which includes subtraction of any Free Water Volume (FWV) from the bottom of the tank. The free water level is either measured manually by hand dipping or automatically with a Free Water Level (FWL) measurement probe connected to the level gauge system. The value from this probe or the manually entered free water level value is entered into the TCT, and the FWV value is subtracted from the TOV.

### 4.1.3 Gross Standard Volume (GSV)

All hydrocarbon liquids change their physical volume in relation to their temperature. When stating a volume value, this would be of no value without stating at what temperature the figure applies to. In the petroleum industry, this temperature value is usually standardized to 15°C or 60°F, where the Celsius value is commonly used in Europe, Asia, Australia and South America. The Fahrenheit scale is

used in North America and often also for crude oil in the Middle East. The conversion of Observed Volume into a temperature Standardized Volume is carried out using the API tables, where a conversion factor is defined.

Since hydrocarbon liquids in the petroleum industry may consist of many hundreds of different individual liquid components, it will be difficult or impractical to determine the volumetric expansion of a product like crude or gasoline based on the individual volumetric expansion of the incorporated liquid components. Instead a simplified approach has become an accepted standard. It is based on the fact that there is a correlation between volumetric expansion and density. Instead of complex investigations of all individual hydrocarbon components in a product, only the density of the product is considered and from that an estimation of the volumetric expansion due to temperature is made. This method is not 100 percent accurate, but as long as all parties in the petroleum business use the same method and base the price on a product on this estimation, it could be argued that the precision of this estimate is acceptable.

This is the essence of the API tables, which were first issued in 1952. In the first issue there was no differentiation between any petroleum products; crude was handled in the same way as gasoline, kerosene or fuel oil. In 1980, a new revision was released which made a differentiation between crude and refined products, where the refined products were also divided into four different subgroups depending on their density range. The 1952 tables were based on printed tables, and the underlying algorithms were not presented. There were even some printing errors in these first tables and some

## 4 - Volume and mass assessment

values were adjusted by hand before printing. These tables would be quite difficult to implement in a computer today.

The 1980 table presented an algorithm which was possible to implement effectively in a computer, but the table had limitations in resolution. This limitation was mainly a consequence of the fact that the intention with the printed table was for the user to have a look-up table and enter values rounded off to the resolution in the table. The tables could be entered into a computer, as long as the software rounded the input values to the same resolution as in the printed table.

With the introduction of computers which simplified all these calculations, and new measurement technologies which had a precision above the resolution in the printed 1980 tables, the request came up to have “tables” that were based on algorithms only and where no rounding of measured values were made. These tables were published in 2004, and are often referred to as “the year 2K tables”. They use the same algorithms which were the base for the printed 1980 tables but do not require the rounding of the input values. With improved measuring devices, they will therefore give different results compared to the 1980 tables, and with better precision.

Today all the tables described above are still in use, and for different reasons. Some users have the 1952 tables as their standard since it appears that oil exporting countries get some benefit from these tables. Many use the 1980 tables, often because they have not yet made any investment in new software to be able to use the new 2004 tables. Buyers of new tank gauging systems often request the new 2004 tables. A supplier of tank gauging equipment must therefore be prepared to have both the new and all the old API tables implemented in the tank gauging calculation software, even though the old 1952 tables may be somewhat awkward to implement.

To change from one revision to another is more complicated than it seems. On a refinery it might mean that there will be a substantial change to the inventory value of products, which could be difficult to handle from an accounting point of view. Also all transfer contracts and pricing to external customers may have to be adjusted to the new revision.

The input values for the API tables are average product temperature and density or thermal

expansion coefficient. The density value used in the API tables must be the density at the same temperature as the reference temperature for the actual table, e.g. the density value for table 54 should be the density at 15°C. In practice this is achieved by taking manual samples of the product on tank, these samples are then measured in a laboratory either with a glass hydrometer or an electronic density meter. The measurement also includes measurement of product temperature, and the corresponding density value is called “observed density” (i.e. the density at the actual temperature during measurement). To be able to use this value in the API table, it should be converted to reference density (using the same temperature that the table refers to). This is made with another API table which is linked to the volume table, i.e. if table 54A is used then there is an API table called 53A which should be used to convert observed density to reference density. The same applies to table 6A, B and C, where there are corresponding API tables called 5A, B and C which give the gravity value for number 6 tables. In modern tank gauging systems all these calculations are normally available, i.e. the user only needs to enter the observed density and related product temperature of the sample, and the tank gauging system will then calculate the value for reference density that should be used for the VCF calculation.

Since engineering units vary globally, the tables are also divided into tables using Celsius temperature and density, Fahrenheit temperature and API gravity, or Celsius temperature and specific gravity (specific weight). Therefore the tables are referred to as:

- Table 6A, crude oil: Conversion using 60 °F and API gravity
- Table 6B, refined products: Conversion using 60 °F and API gravity
- Table 6C, special products: Conversion using 60 °F and thermal expansion coefficient
- Table 54A, crude oil: Conversion using 15 °C and density (at 15 °C in vacuum)
- Table 54B, refined products: Conversion using 15 °C and density (at 15 °C in vacuum)
- Table 54C, special products: Conversion using 15 °C and thermal expansion coefficient

The output from the API tables as above is a value called Volume Correction Factor (VCF).

The Gross Standard Value (GSV) is then given by:

$$GSV = GOV \times VCF$$

It should be noted that the C tables above may be used for special products where the thermal expansion coefficient is known. This is mainly the case where only one or a few single hydrocarbon components are present. There is also some use of API tables, mainly in some South American countries, which are based on specific gravity (specific weight) and temperature corrected to 20 °C.

### 4.1.4 Net Standard Volume (NSV)

The Net Standard Volume (NSV) is the same as GSV unless there is a measurable content of base sediment and suspended water (BS&W) in the product. This is mostly common in crude oil and measured at laboratories in percent. Therefore, the NSV is given by:

$$NSV = GSV - BS\&W \times GSV$$

## 4.2 Mass assessment

Standardized volumes are vital for a number of operations in the petroleum and terminal industry such as custody transfer, inventory management etc. Sales of petroleum are in most cases based on NSV, but there are a few exceptions where the mass value is used in transactions. China is one example that has practiced mass based custody transfer over a number of years. Also, when selling refined products over a weighing bridge it would be natural to sell the quantity in mass terms. LPG is another example where sales are often based on mass, using mass flow meters for the measurement.

However, loss control is normally the most common use case for mass measurement. If we imagine a refinery which wants to estimate the efficiency or the losses that occur in the process, volume is not an option to use. The reason is that if they measure the product input in volume terms then they cannot compare that to the output volume from the plant,

since the chemical process changes the physical composition of the crude oil. In theory one could actually get more volume out from a refinery than was put in.

It is different with mass, where the output would be the same as the input if no losses occur and no addition of weight is made in the process. Therefore loss control is based on mass, not volume.

The term “mass” also needs an explanation, since by definition it is the Weight in Vacuum (WiV). In practice this unit is rarely used; the term Weight in Air (WiA) is more common. WiA is calculated by subtracting the weight of 1 cubic meter of air from WiV. The weight of 1 cubic meter of air is typically 1.22 kg, which value is used in the calculation. This value should be programmable for the operator since it may vary slightly from country to country.

## 4.3 Quantity assessment of liquefied petroleum gases

As mentioned in chapter 3, LPG transfers are generally based on mass using mass flow meters. Quantity assessment in volumetric terms is not uncommon however, particularly for inventory purposes, and in rare cases also for transfer. The calculation of LPG volume is however problematic, as the calculation of VCF via the API tables is not supported. The reason for this is that the density range for LPG products is below what modern API tables are defined for. This is true for tables from 1980 and onwards, but the very old API tables from 1952 have a density range which could allow them to be used for LPG products. The input from users has shown that it is a quite common practice to use the old 1952 tables despite the fact that they are only available as printed tables (no defined data algorithm is available), and they also have some printing errors in the tables. This is of course not an ideal situation, but since no other API tables are available this is currently the only option.

There are also some special calculations for LPG products since tanks containing liquefied gases may have a substantial amount of product in the gas phase. To calculate the total product volume, the tank gauging system must be able to accurately assess product volume and mass in both liquid and gas phases. This involves the calculation of Vapor Liquid Volume Ratio (VLVR) which requires measurement of the vapor pressure in the tank.

## 4 - Volume and mass assessment

For this reason, an LPG level gauge should have a pressure sensor attached (often integrated) for the VLVR measurement.

The VLVR calculation method was published in a preliminary ISO standard which did not receive the status as a final standard. However since the calculation is based on general physics, the method has received acceptance in the industry as the standard method for calculation of VLVR.

An inventory control system as described above can automatically carry out the total volume assessment based on the tank liquid level, the volume tables, the product properties and pressure measurement.

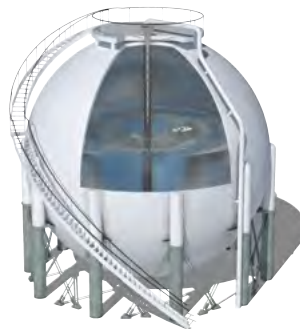

Figure 4.3: A pressurized tank with product in both liquid phase and gas phase.

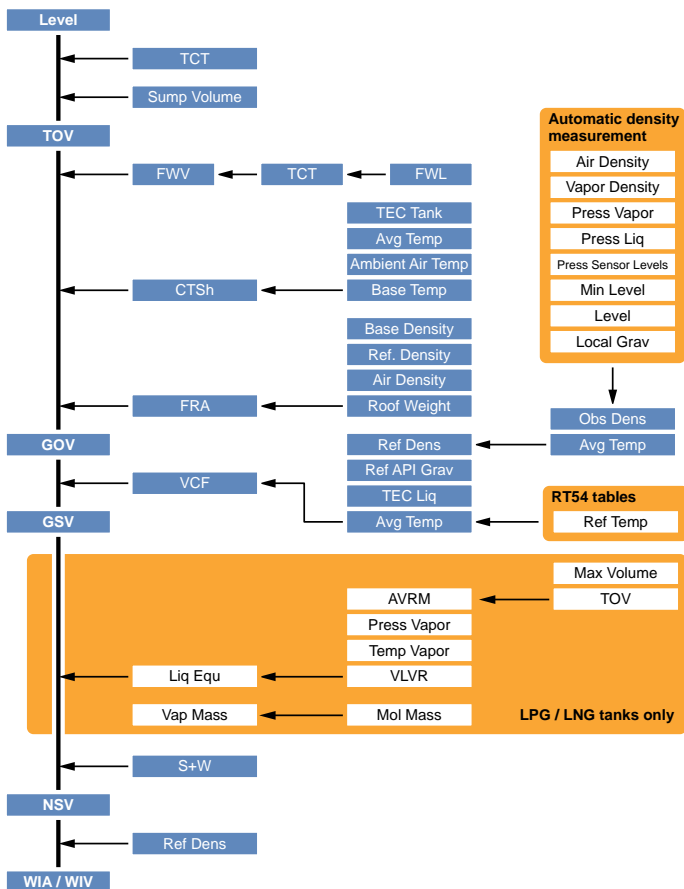

Figure 4.4: Detailed volume calculation flowchart.



## Accuracies and uncertainties

| Topic | Page  |
|-------|---|
| 5.1   | Uncertainties in tank gauging systems 35              |
| 5.2   | ATG system vs. flow meter system 37                   |
| 5.3   | Process level gauges vs. tank gauging level gauges 38 |
| 5.3.1 | System architecture 38                                |
| 5.3.2 | Accuracy statement 38                                 |
| 5.3.3 | Lifetime expectations 39                              |
| 5.3.4 | Installation 39                                       |
| 5.3.5 | Installation on still-pipes 40                        |



## 5. Accuracies and uncertainties

The term “accuracy” is used in most level gauge manufacturers’ sales documents. The definition of accuracy is however somewhat unclear, unless the manufacturer has actually specified it. It should also be noted that in more precise documents like the OIML R 85 this word is not used or defined. Customers may ask themselves: does the accuracy figure also apply when the level gauge is installed on a tank? Does it consider all types of parameters (temperature, pressure, EMC, ageing etc.) that may influence the operation of the level gauge, and does the figure mean that all level gauges will never show an error larger than the accuracy statement?

The reason for using the word accuracy is likely to have a historical explanation, and it could be assumed that since the interpretation varies, that is also what some manufacturers want. Going back to the questions above, it is worth considering the following:

### Does the accuracy figure also apply when the level gauge is installed on a tank?

A responsible supplier of tank gauging systems will clearly state that the figure applies to what is called *reference conditions* and the supplier should also be prepared to show the customer how these reference conditions are set up. In other words, the user should obtain a document from the supplier which details the conditions in which the accuracy statement was originated. The measuring range and the temperature range should be addressed, and there should be an uncertainty calculation of the precision of the reference measuring system etc.

A responsible supplier will not guarantee the installed accuracy, since that means guaranteeing the skill of the persons making the comparing hand dip, guaranteeing all types of conditions that could occur in the tank, and also guaranteeing the mechanical stability and method of installation for each tank. It is not possible to guarantee all these things without making a time consuming investigation, for which in most situations there is neither time nor resources available. A vendor that gives such guarantees

without knowing anything about the tanks or operation of the tanks should be looked upon with some suspicion by the user.

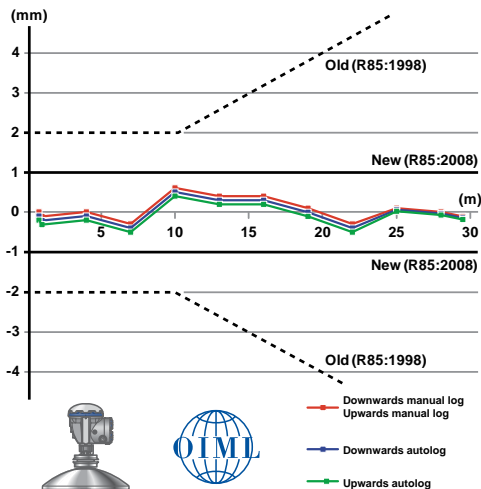

Figure 5.1: Graph showing OIML level accuracy requirements with a high performance radar gauge.

Often when a user buys a tank gauging system there is a certain goal that must be achieved, like: “the system should be used for legal custody transfer”. This means that it should not only fulfil the requirements of accuracy under *reference conditions*, but also fulfil the system requirements when installed on a tank. This could mean that the user needs to calculate how much it would cost to make modifications to the tank to be able to fulfil the installed accuracy statement. In this whole process the experience and the help a manufacturer can contribute is of great value to the user. A tank gauging supplier may have experience from more than 100 000 tank installations, and also have a record and a reputation which may be easily checked by the user. In this respect it is a good idea for the customer to check for references from other users who have tank gauging systems installed where the requirements are high.

### Does the accuracy figure apply to all types of influences (temperature, pressure, EMC, ageing etc.) that may occur during the operation of the level gauge?



A level gauge which normally has an excellent performance but performs poorly when an operator starts using their walkie-talkie, or during a very warm summer day, is not what a user wants. One easy way for a customer to ensure the tank gauging system is suitable for the intended operation, is to check if it has been OIML R 85 approved. The customer should also check that it is approved according to the latest revision of R 85, which is currently from 2008. A serious supplier should also be prepared to give the customer a copy of the R 85 test report if the customer wants to check the results from the tests. The OIML R 85, 2008 is probably the best guarantee a user can get with regards to these questions, except possibly for the issues related to ageing.

The ageing of a tank gauging system is of great importance, since its lifetime can be some 15-20 years or even more. The environment in a refinery or tank terminal is often harsh, with high salt and sulfur content in the air, solvents that attack rubber or plastics and UV-radiation which breaks down paint and plastics. References from other installations are the best way to ensure that a long lifetime system is selected.

Since the lifetime is long for a tank gauging system, spare part availability is also important. Spare parts from third parties may affect the performance of the system and should be avoided. The supplier should also show their life-cycle policy for spare parts.

**Does the accuracy figure mean that all level gauges will never show an error larger than the accuracy statement?**

The accuracy figure may also mean *typical accuracy*, meaning that the figure has some statistical distribution (e.g. Gaussian) where some units are within the range of the figure, but a certain distribution may be outside. In this case the word accuracy could be exchanged for *uncertainty* which is a more appropriate term for a statistical method of expressing performance. When statistical means are used for the expression of performance, it is also important to define the confidence interval for the value, i.e. the sigma ( $\sigma$ ), where normally 2 sigma or 3 sigma are used.

Manufacturers who test every level gauge individually before delivery can claim that the accuracy figure is the maximum deviation that the unit will show during final testing. The figure is then an approval criteria in the production. OIML R 85, 2008 states requirements for use in legal custody transfer as: Maximum Permissible Error (MPE) shall be  $\pm 1$  mm (0.04 in.). If every delivered unit is tested to be within this criteria, then the accuracy figure consequently means all units are within the stated figure.

Also important is the uncertainty in the reference measurement system when establishing the accuracy figure. A metrological rule of thumb is that the reference shall have an uncertainty at least 3 times better than the figure it should verify. For verification of a stated accuracy of 0.5 mm (0.02 in.) this would then require a reference uncertainty in the range of 0.17 mm (0.0067 in.), which implies very high requirements on the reference measuring system, and it typically requires expensive arrangements with tracking laser equipment etc.

### 5.1 Uncertainties in tank gauging systems

Following section aims to give some understanding of what uncertainties can be achieved in a tank gauging system.

A modern radar level gauge is capable of an intrinsic accuracy (accuracy at reference conditions) of maximum error  $\pm 0.5$  mm (0.02 in.) and over the whole temperature range ( $-40$  °C to  $85$  °C) the maximum error should be within  $\pm 1$  mm (0.04 in.). The installed uncertainty on the tank may be estimated to be in the range:

*Level uncertainty (installed) = 2 mm*

This assumes a high performance custody transfer level gauge with proven performance. The method of installation is important; the installed level gauge must be rigidly mounted to the most mechanically stable point of the tank. This is normally accomplished by installing the level gauge on a still-pipe, which is either mechanically fixed to the tank bottom or the lower corner between tank wall and tank bottom. For further installation guidelines see [API Ch. 3.1B](#). Certain corrections may be necessary to achieve 2 mm installed accuracy like correction of thermal expansion of still-pipe etc. Corrections like this should be available in these types of level gauges.

## 5 - Accuracies and uncertainties

One problem could be to verify an uncertainty in this range with hand dip. It would require a very experienced person to make hand dips with an uncertainty in the range of 1 mm (0.02 in.) or less, but some metrological authorities claim that it is possible. It is clear however, that this is not a common day-to-day practice because it can only be done under very well controlled conditions.

Level uncertainties in transfers are affected by the fact that a custody transfer is a difference measurement, i.e. the difference in level at start and at end of transfer is measured. Some types of errors will thereby be cancelled out in a cylindrical tank, e.g. an offset error of the level gauge will be the same before and after transfer, and will subsequently have no (or very little) influence on the transferred batch.

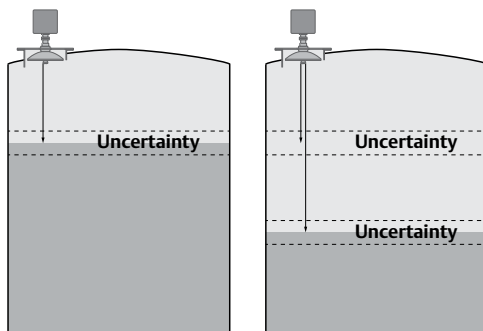

Figure 5.2: Uncertainty when measuring batches could be reduced by offset error elimination.

*Uncertainty in average product temperature: 0.3 °C*

To achieve 0.3°C installed accuracy, a multi-spot Resistance Temperature Detector (RTD) with sensor elements at various heights in the product is required in most cases. A stable electronic temperature conversion unit converts the resistance

value to digital format, and the electronics should be designed for full accuracy at actual ambient temperature conditions.

*Uncertainty in density measurement: 0.5-1.5 kg/m<sup>3</sup>*

Figures on accuracy for manual density sampling are often in the range of 0.5 kg/m<sup>3</sup>. The actual accuracy of laboratory measurements is better, but the handling of the sample on the tank roof, and how well the sample represents the product may introduce additional errors.

For automatic measurement with the hybrid type system (see [chapter 8](#)), the accuracy is mostly determined by the precision of the pressure transducer. The accuracy will also vary depending on the liquid level in the tank, i.e. at low liquid levels the accuracy will deteriorate, since offset drift in the pressure transmitter will affect the reading more than at high liquid levels. Typical accuracy figures which are achievable with standard pressure transmitters are around 1.5 kg/m<sup>3</sup> at 3 meter liquid level (with better results at higher levels).

The main impact density has on the transfer calculations is seen when using API tables for calculation of Volume Correction Factor (VCF) and standardized volume. However, the API tables are not very sensitive to density variations. In most areas of the API table the density can be varied by approximately 7 kg/m<sup>3</sup> without any visible change in the last decimal of the VCF figure. An example is shown in table 5.1, where density can vary from 739.4 – 746.9 kg/m<sup>3</sup> without affecting the value of the VCF figure.

*Uncertainty in Tank Capacity Table: 0.01-0.10%*

The precision in the Tank Capacity Table (TCT) varies with respect to which calibration method

|                                      |        |        |        |        |        |        |        |        |        |        |
|--------------------------------------|--------|--------|--------|--------|--------|--------|--------|--------|--------|--------|
| Density at 15°C (kg/m <sup>3</sup> ) | 739.0  | 739.4  | 741.3  | 742.0  | 742.8  | 745.0  | 745.8  | 746.5  | 746.9  | 747.2  |
| Uncertainty (% reading)              | -0.80  | -0.75  | -0.50  | -0.40  | -0.30  | 0.00   | 0.10   | 0.20   | 0.25   | 0.30   |
| VCF Computed                         | 0.9938 | 0.9939 | 0.9939 | 0.9939 | 0.9939 | 0.9939 | 0.9939 | 0.9939 | 0.9939 | 0.9940 |

Table 5.1: Density variation does not affect the Volume Correction Factor to a large degree.

## 5 - Accuracies and uncertainties

has been used, and the time since the calibration was performed. Old calibration methods often state an uncertainty of 0.10% in the TCT, but recent calibration methods based on EODR (Electro-Optical Distance Ranging) have shown figures as low as 0.01% – 0.02%.

The fact that custody transfer is a difference measurement also affects the uncertainty in the TCT, and errors are to a certain degree cancelled out. Particularly on small transfers this cancellation effect can have a large impact and uncertainty may be better than the figures above. Also, an offset error due to difficulties in estimation of the bottom volume will thereby have no (or very little) influence on the transferred batch, since this part of the tank should not be used for transfers.

So what will the above uncertainties end up as when it comes to standardized volume and mass? To answer this question, all the uncertainties above need to be taken into account for calculation of a figure. This work has been discussed within OIML R 85 for a number of years, but a document has so far not been issued and no working committee has been set up. The figure that has been discussed as a requirement for custody transfer has been in the range of 0.5 % based on mass, and this is also a figure that some metrological authorities use today when they use mass based custody transfer. The future will tell what requirements will be set in forthcoming standards.

### 5.2 ATG system vs. flow meter system

A tank gauging supplier often gets the question: “How accurate is a tank gauging system compared to a flow meter based system at transfers?” This question may be answered “It depends on the actual transfer”, but one basic fact is illustrated in figure 5.3 below:

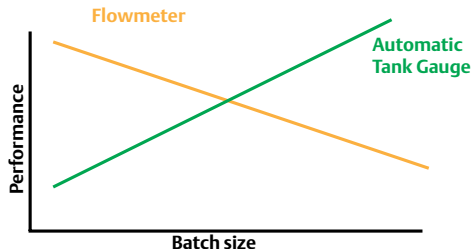

Figure 5.3: ATG systems perform better than flow meter systems when handling large batches, and vice versa.

Figure 5.3 shows that in general an Automatic Tank Gauge (ATG) system is superior for handling large transfer batches, and a flow meter system is superior for smaller batches. Where the intersection of the two curves is located varies between different tanks, and the shape of the tank has certain influence. There is however a lot of other factors that also may influence the performance, and in general it can be said that:

ATG's may not perform well if:

- Batches are small
- Tank Capacity Table is old or badly strapped
- Tanks are deformed or mechanically unstable

Meters may not perform well if:

- Batches are large
- Product contains abrasive material, sand etc. which damages mechanical parts
- Product is viscous (bitumen, lube oil, waxy crude etc.)
- There is a lack of proper meter calibration facilities

The last point above may be considered in particular. Calibration of an ATG system is normally very simple and low cost compared to meters which require complex and expensive equipment.

What should also be considered is that an ATG system is normally also required for other purposes such as:

- Operational control
- Inventory control
- Mass balance and loss control
- One independent layer of overfill prevention and leak alarm

If we assume there always has to be an ATG system installed for the above purposes, the additional cost for using the ATG system for custody transfer can also be estimated. There is a somewhat higher price for a custody transfer class ATG system, compared

to a system with lesser performance. However, the lifetime of an ATG system is often very long with an average of around 15-20 years. In this time perspective the additional investment in better performing equipment will be negligible. Also, the procedure of supervision of the performance (subsequent verification) when the system has been installed on a tank is limited to some hours per year by an independent resource. The total overall additional cost to have an ATG system with certified custody transfer performance can therefore be considered low.

The status of the Tank Capacity Table should also be considered. It is well worth considering a re-strapping of an old tank according to new modern methods, especially if the strapping was made a long time ago. The cost for re-strapping may not be high considering the measurement error in terms of product volume that can occur during a single emptying or filling operation of a tank.

For product transfers, many operators use both an ATG system and a flow meter based system. They can then compare the result from both technologies and investigate the cause if the difference is too large.

### 5.3 Process level gauges vs. tank gauging level gauges

It may be tempting for a user to go for a radar based process level gauge in a tank gauging application, since the cost often is lower (see [chapter 2](#)). In this case there is a number of important factors to bear in mind, presented in the following sections.

#### 5.3.1 System architecture

Most process level gauges are designed to produce only level information to a DCS system, and there are no particular ATG functions available. Such a function could be an integrated average temperature measurement which considers the level in the tank, correction algorithms for tank wall expansion, temperature correction of Tank Capacity Tables etc. Also, most process level gauges are using a 4-20 mA current loop which has a resolution that is too low for tank gauging purposes, and the unit may lack communication possibilities for a more efficient or advanced digital bus. Some tank gauging systems also have the possibility to handle existing cabling from old mechanical level gauges, and can often coexist with them by emulating the old level gauges. Software functions for complex standard volume and mass calculations are also required and these are normally not available in standard PLC or DCS systems.

#### 5.3.2 Accuracy statement

A process level gauge is often optimized to handle difficult operating conditions such as turbulent liquids, product foam, high pressure and temperature. In such conditions the focus is not on accuracy. Despite this, accuracy statements like “3 mm accuracy under reference conditions” for a process level gauge may be seen. This may be true under reference conditions, but in a tank gauging application it is necessary to know how big the temperature influence is. Typically there is a very big discrepancy compared with a tank gauging level

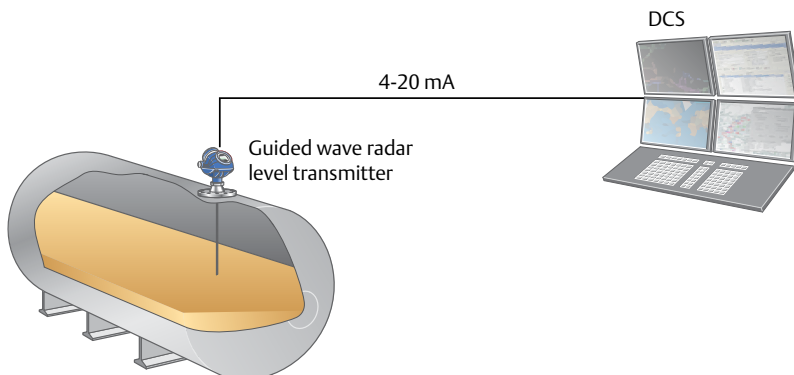

Figure 5.4: Typical process level transmitter architecture.

## 5 - Accuracies and uncertainties

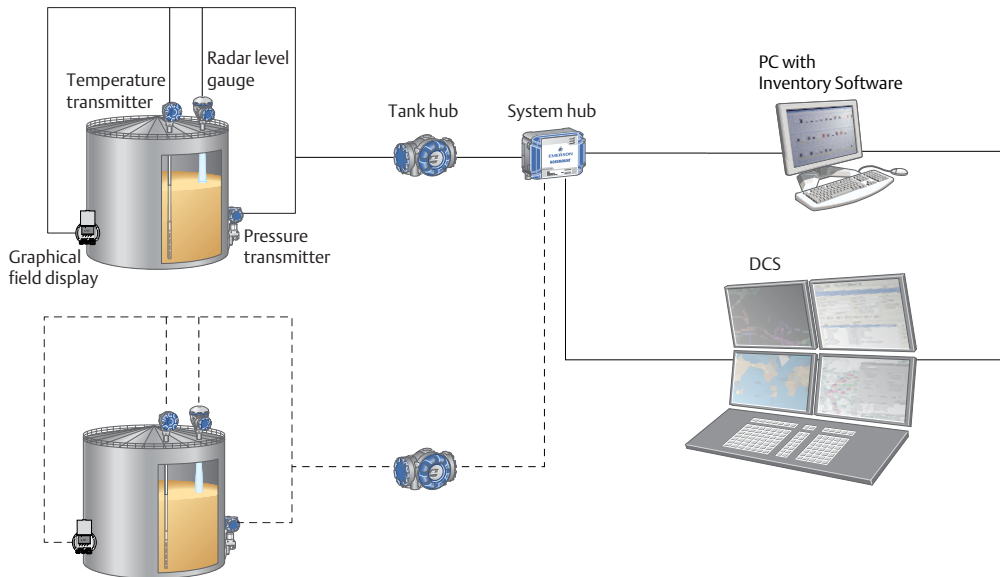

Figure 5.5: Typical tank gauging system architecture.

gauge, which if OIML R 85 approved, is not allowed to vary more than 1 mm (0.02 in.) in the whole ambient temperature span. If the statements on temperature influence on a process level gauge (if stated at all by the manufacturer) are checked, typical figures on accuracy in the range of 20 mm (0.8 in.) or more over the intended ambient temperature range can be seen. This temperature dependency often makes the process level gauge unusable in a tank gauging application. Just a difference in temperature between day and night may be enough to make an operator nervous, since it could look like there is a leakage in a non-active storage tank. Inventory estimations can vary considerably with the weather, and mass balance and loss control may be inaccurate.

The difference in temperature influence between a typical process level gauge and an ATG is due to the technology used. An ATG level gauge is normally based on FMCW technology which is easier to design with little temperature influence, compared to a pulsed (also called time-of-flight) process level gauge, where it is a challenge to get the timing circuitry temperature stable.

### 5.3.3 Lifetime expectations

The lifetime of a tank gauging system is often in the range of 20 years or even more, which is rarely the case for a process level gauge. During this time period there must be spare parts available to secure maintenance without serious operational disturbances. The lower cost and the simple 4-20 mA connection to a DCS system used by a process level gauge may imply that a change of the complete level gauge unit is all that is required. A check of the manufacturers' life-time policy may be important.

### 5.3.4 Installation

A process level gauge is often designed for installation on smaller vessels with narrow openings, which often would disqualify a typical ATG level gauge. ATG level gauges based on radar often have larger antenna apertures to allow installation on available manways on storage tanks. These are often located close to the tank wall since this section is regarded as a reasonably stable installation point.

The larger antenna aperture on an ATG level gauge will allow installation close to the tank wall without degraded performance resulting from interfering radar echoes from the tank wall. An antenna that is too small would in this case have its installed accuracy affected by the interfering echoes. It is possible to increase the frequency of the radar signal to some extent to get higher directivity of the transmitted radar beam and thereby avoid tank wall influence. There are however other disadvantages with higher frequencies and since the size of the tank openings is rarely critical on storage tanks, they offer no benefits in most cases.

### 5.3.5 Installation on still-pipes

In ATG applications it is common that the level gauge installation is made on a still-pipe. The reason is that a still-pipe, correctly installed at the tank bottom or lower part of the tank wall is a very stable reference point for the level measurement. Another reason may simply be that the tank has a floating roof, and it is necessary to penetrate the roof with a still-pipe to get access to the liquid surface.

The percentage of installations that require installation on still-pipes is approximately 50% in ATG installations and close to 0% for process installations. As a result of this it is very rare to see process level gauges supplied with the special type of radar antenna that is required for high performance installations on still-pipes. To use a standard free-propagation device on a still-pipe would give very poor measuring results since they do not have the special H01 transmission mode which is necessary (see [chapter 2](#)). This absence of a suitable antenna solution for still-pipes may therefore be the major difference between a radar based ATG level gauge and a process level gauge.

# 6

## Temperature measurement

| Topic   | Page |
|---|------|
| 6.1 Influence of API tables_____                                    | 43   |
| 6.2 Systematic measurement errors_____                              | 44   |
| 6.3 API standard_____   | 44   |
| 6.4 Location of spot elements_____                                  | 45   |
| 6.5 Additional uses of temperature measurement in tank gauging_____ | 45   |
| 6.5.1 Correction of tank height_____                                | 45   |
| 6.5.2 Correction of Tank Capacity Table_____                        | 46   |
| 6.5.3 Correction of hand dip tape_____                              | 46   |



## 6. Temperature measurement

Measurement of product temperature is vital in a tank gauging system for input to the Standard Volume and Mass calculation, and it has a greater importance than some users may think. In the past (and also to some extent today), storage tanks could be seen with only one temperature sensor mounted on the tank wall near the bottom of the tank. This type of arrangement will not show a representative value of the overall product temperature, since all storage tanks will show a considerable temperature gradient from top to bottom. This can to some extent be minimized by agitation of the product, but agitation is in most cases unwanted since it will increase evaporation in or from the tank. Figures on how much temperature difference can be expected in a normal cylindrical tank that has been settled is in the range of 1-4 °C in a vertical direction. Cold products will have higher density and will therefore end up at the bottom of the tank. The temperature gradient in a horizontal direction has often been debated, but under normal conditions API documents state that the horizontal temperature difference in a storage tank is less than 0.5 °C.



Figure 6.1: Top mounted temperature transmitter for up to 16 spot temperature elements.

### Example 6.1: Volume error given by temperature error

The following example illustrates how large volume error will be given by an error in the average product temperature of 1 °C:

In a normal, typical cylindrical shape product tank, with a height of 20 m, a diameter of 36 m, and a total tank volume in the range of 20 000 m<sup>3</sup>, the error in volume will be:

$$\text{Volume error} = 20\,000 \times 700 \times 10^{-6} = 14 \text{ m}^3$$

where  $700 \times 10^{-6}$  is based on the assumption that the volume of petroleum products is affected by temperature in the range 600-800 ppm per 1 °C.

This may not seem too alarming, but if one considers that the temperature error might be systematic, i.e. if a similar error occurs every time when filling or emptying a tank, it will cause considerable loss to one of the parties involved in the transaction.

In a tank the same size as in example 6.1, a level error will correspond to approximately 1 m<sup>3</sup> for each mm. The 1 °C error in temperature will then influence the volume the same as a level gauge error of 14 mm!

The tank gauging system is therefore poorly matched if the level gauge has an installed accuracy in the range of a few millimeters and the temperature measurement has an accuracy of ±1 °C. To be able to



## 6 - Temperature measurement

end up in the same accuracy class as the level gauge, the temperature measuring system must first of all be able to handle the temperature gradient. That is, it needs to be of the multi-spot type measuring temperature at different heights in the tank and calculating an average from the sensors which are submerged in the liquid. Secondly, the temperature sensor combined with conversion electronics should have an accuracy far better than  $\pm 1\text{ }^{\circ}\text{C}$ .

### 6.1 Influence of API tables

A limitation in the temperature measurement related to the API tables and the Volume Correction Factor (VCF) calculation should be considered. The API tables before 2004 only had a resolution of  $0.25\text{ }^{\circ}\text{C}$  ( $0.5\text{ }^{\circ}\text{F}$ ), which made temperature measurement accuracies better than  $0.25\text{ }^{\circ}\text{C}$  meaningless. The typical sensor type that is used in this case is 3-wire Pt100 elements, where the error due to different resistance in the three wires in most cases should be possible to get below  $0.25\text{ }^{\circ}\text{C}$ .

Still, if the temperature precision is only as good as  $0.25\text{ }^{\circ}\text{C}$ , the corresponding level error in the tank example above is in the range of several millimeters, and on large crude tanks the figure can be a lot larger. A modern level gauge has an intrinsic accuracy of  $0.5\text{ mm}$  ( $0.02\text{ in.}$ ) and when applying certain tank corrections the installed accuracy could be in the range of  $2\text{ mm}$  ( $0.08\text{ in.}$ ) or better. This is why it is important to decrease the error in the temperature measurement, and to arrive at an accuracy in the range of  $0.1\text{ }^{\circ}\text{C}$  or better. Since the introduction of the new higher resolution 2004 API tables, using these high accuracies is now highly relevant.

The 2004 tables are different compared to all the earlier tables in that they do not use the tabulated VCF value (the printed value) from the API table. Instead it is the result from the algorithm behind the table that is the correct value. This is a consequence of the fact that operators today do not use the table value but instead have a computer program which has the algorithm implemented to enable the computer to make the calculation. However, when the computer makes the calculation for the old tables it should round off the temperature value to nearest  $0.25\text{ }^{\circ}\text{C}$ , to get the same result as in the printed table. This is different in the 2004 table, where the rounding instead should be to the nearest  $0.1\text{ }^{\circ}\text{C}$ . This means that if the temperature system has measured and calculated an average liquid temperature of  $18.37\text{ }^{\circ}\text{C}$ ,

the value  $18.4\text{ }^{\circ}\text{C}$  should be used in the algorithm, not  $18.25\text{ }^{\circ}\text{C}$  as with the old tables.

The new API tables open up possibilities for better volume estimation through more precise temperature measurements. The resistance difference possible in a 3-wire Pt100 system is therefore not uncritical anymore, and there is a clear trend to go for 4-wire Pt100 sensors instead. A 4-wire Pt100 sensor will fully compensate for the resistance difference in wires from conversion electronics to the Pt100 element. It requires a resistance to temperature conversion unit that is designed for 4-wire connections, and the conversion electronics should have sufficient accuracy and ambient temperature stability.



Figure 6.2: Left - Multi-spot temperature sensor with Pt100 elements and corrosion resistant metallic sheath. Right - Complete temperature measuring assembly with transmitter, sensor, optional water level sensor and anchor weight.

The Pt100 sensor elements exist in different accuracy classes, and in general 4-wire elements use the highest accuracy classes. Some manufacturers also issue a calibration sheet together with each element. This calibration sheet could then be used for entering corrections of the sensor element and thereby improving the accuracy even more. To do this automatic calibration, a corresponding function must be available in the temperature measuring system.

## 6 - Temperature measurement

To summarize, it could be stated that temperature measurement must not be a limiting factor for a proper performance matching with the level gauge in a tank gauging system. However, the aspects above should be considered and they are as important for correct volume estimation as the performance of the level gauge.

### 6.2 Systematic measurement errors

Measurement errors that can be described as systematic should be avoided as far as possible in a tank gauging system, since they will multiply over time and can create a considerable loss for a buyer or a seller. For level measurement with a radar level gauge, the error is mostly of a random type but for temperature measurement it can often be systematic.

#### Example 6.2: Temperature measurement using only one sensor

In a common case where only one temperature sensor is installed at the bottom of the tank it is certain that this will not represent the average temperature of the product in a settled tank. If the temperature gradient is 4 °C the temperature sensor can be expected to show an error in the range of a 2 °C too low average temperature each time a transfer from a full tank is started. Expressed in Standard Volume it means the volume is overestimated at the start, and in example 6.1, this would for a typical tank correspond to an error of 28 m<sup>3</sup>. This means that 28 m<sup>3</sup> less is delivered than the measurement indicated. The implication is that the error is approximately the same every time a transfer from this tank takes place, since the temperature stratification, due to its physical nature, is systematic. With a turn-over rate of 30 times per year, it will end up in the range of 800 m<sup>3</sup> per year or some 40 full tank trucks, for one tank only.

The scenario in this example illustrates the importance of using a multi-spot temperature sensor, but it is still important to take care, since an error in one temperature element could cause a similar systematic error; the faulty temperature

element may only be included in the average temperature measurement at certain liquid levels and excluded at lower levels. The quality of the multi-spot sensor is therefore important, and the performance of each element may be subject for check at certain intervals.

**Example 6.3:** Volume error caused by temperature error compared to corresponding level gauge error for a 20 m high tank with a diameter of 36 m and a volume of 20 000 m<sup>3</sup>.

| Temperature error (°C) | Resulting Volume error (m <sup>3</sup> ) | Corresponding Level gauge error (mm) |
|------------------------|--|--------------------------------------|
| 0.25                   | 3.5                                      | 3.5                                  |
| 0.50                   | 7  | 6.9                                  |
| 0.75                   | 10.5                                     | 10.3                                 |
| 1.00                   | 14                                       | 13.8                                 |
| 1.25                   | 17.5                                     | 17.2                                 |
| 1.50                   | 21                                       | 20.6                                 |
| 1.75                   | 24.5                                     | 24.1                                 |
| 2.00                   | 28                                       | 27.5                                 |

### 6.3 API standard

API MPMS chapter 7.3 “Temperature Determination – Fixed Automatic Tank Temperature Systems” was released in 2011 and describes the methods, equipment and procedures for determining the temperatures of petroleum and petroleum products under static conditions by using an automatic method.

Guidelines for equipment and design requirements are given, among other things recommending Resistance Temperature Detectors (RTD’s) and the use of multi-spot averaging sensors for custody transfer applications. It provides installation and accuracy requirements and suggests procedures for the inspection and verification of a complete Automatic Tank Thermometer (ATT) system.

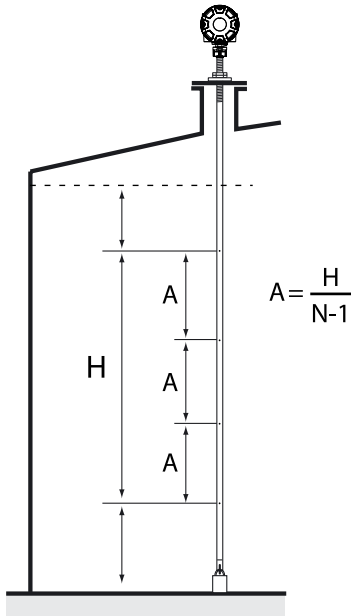

Figure 6.3: Spot temperature elements should be placed with equal distance between each element.

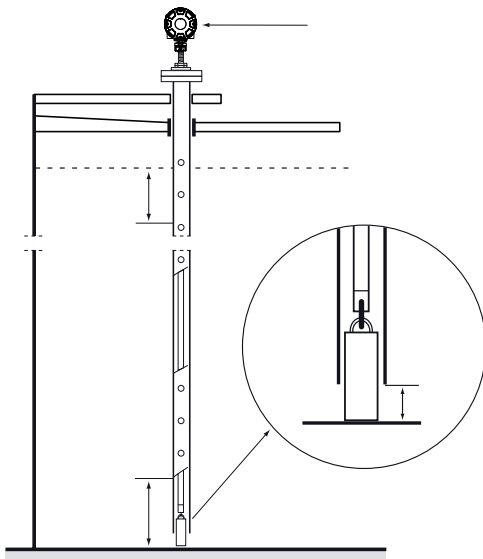

Figure 6.4: On floating roof tanks, a still-pipe is often used for the temperature sensor installation.

### 6.4 Location of spot elements

To achieve a good representation of the average temperature in an upright cylindrical tank, the temperature spots should be evenly positioned with at least 2-3 m intervals.

To avoid possible influence from ground temperature, the lowest spot should be placed around 1 m from the tank bottom. Furthermore, to avoid ambient temperature influence, the sensor should be installed at least 1 m from the tank wall and close to a gauging hatch for verification purposes.

### 6.5 Additional uses of temperature measurement in tank gauging

In addition to the use for Standard Volume calculation, the temperature measuring system is also used for other purposes, see following example:

#### 6.5.1 Correction of tank height

Most level gauges measure the distance from their mounting position down to the liquid surface (ullage measurement), and calculate the level by subtracting ullage from the reference height (the distance from the level gauge mounting point to the datum plate). This calculation will show an error if this distance is not constant, i.e. the level will vary with the reference height change. One type of change which is easy to compensate for is the thermal expansion/contraction of the tank wall or the still-pipe. With a multi spot temperature sensor installed from the top of tank down to the bottom, an average temperature value of either the tank wall or the still-pipe can be estimated. In this case all individual temperature elements are used for the average temperature calculation, and a correction can be applied on the reference height based on thermal expansion of carbon steel (10-12 ppm/ °C).

For correction of a tank wall, the fact that there is liquid on the inside of the tank and air on the outside, as well as different media involved, should be taken into account. The thermal influence is quite different for air and liquid and API has stated that tank wall temperatures in each measuring point should be calculated as:

## 6 - Temperature measurement

$$T_{\text{tank wall}} = \frac{1}{8} T_{\text{ambient}} + \frac{7}{8} T_{\text{liquid}}$$

The ambient temperature can be difficult to measure since it may be affected by sun radiation, and position of the actual temperature sensor on the tank. A correct ambient temperature would probably need an advanced metrological station on each tank and in practice most users do not make this investment since the influence is quite small. The accuracy of the temperature measuring system is uncritical for this correction, see example 6.4.

### Example 6.4: Reference height error

An error of 5 °C when doing a correction of a 20 m high still-pipe or tank wall will only give an error on level as:

$$\text{Reference height error} = 5 \times 10 \times 10^{-6} \times 20\,000 = 1 \text{ mm}$$

where  $10 \times 10^{-6}$  is based on the assumption that a carbon steel tank wall expands 10 ppm/1 °C.

A modern level gauge system should, if required, have the capability to correct these reference height changes.

tank already has a temperature measuring system, it is an easy operation to activate the correction in the software, so there should be no reason not to use it.

### 6.5.3 Correction of hand dip tape

When making a reference measurement with hand dip it should be considered that the hand dip tape only shows the correct value if the hand dip tape has the same temperature as when it was calibrated.

For normal daily hand dip it may not be necessary to correct for this temperature influence, but when making reference measurements or measurements in heated tanks the hand dip tape may show large errors. Below is an example from a heated bitumen tank.

### Example 6.5: Tape error in heated bitumen tank

Tank same as before: 20 m high, half full, temperature in tank above liquid 170°C, tape calibrated at 20°C, ullage dip (due to bitumen):

$$\text{Tape error} = (170-20) \times 10 \times 10^{-6} \times 10\,000 = 15 \text{ mm}$$

With this ullage dip at 10 m, the tape will show a 15 mm error reading.

### 6.5.2 Correction of Tank Capacity Table

A Tank Capacity Table (TCT) is only valid at a certain temperature, i.e. the temperature the tank shell had when it was calibrated. The product temperature will affect the tank shell which will expand or contract depending on the temperature. The same tank as in the previous example (20 000 m<sup>3</sup>) is affected by a temperature change of 5 °C from its calibration temperature as:

$$5 \times 20 \times 10^{-6} \times 20\,000 = 2 \text{ m}^3$$

where  $20 \times 10^{-6}$  is based on the assumption that the area expansion of a carbon steel tank wall is 20 ppm/1 °C.

The error received when not making this correction of the TCT may not upset a user, but in large or heated tanks the error may be much larger. If the

If the tank has an installed temperature measuring system, this may be used for estimation of the temperature of the tape after insertion in the tank. In general the tape will very quickly adopt the same temperature as the vapor in the tank, therefore the vapor temperature measured by the tank gauging system could be used for the correction.

# 7

## Liquefied gases

| Topic                            | Page |
|----------------------------------|------|
| 7.1 Radar tank gauging for LPG   | 48   |
| 7.2 Radar tank gauging for LNG   | 49   |
| 7.3 Typical system configuration | 49   |



## 7. Liquefied gases

Radar tank gauging has been used on liquefied gas tanks since the 1980's. Today, several thousands of pressurized Liquefied Petroleum Gas (LPG) tanks and non-pressurized Liquefied Natural Gas (LNG) tanks are equipped with high performance radar tank gauges.

A successful radar level gauge design for liquefied gases should be based on using a still pipe in the tank. The radar gauge is bolted to a tank nozzle at the top of the tank. A still pipe, normally with a 100 mm (4 in.) diameter, is connected to the same nozzle and reaches down to the bottom of the tank.

The still pipe is equipped with one or more verification pins. These pins are mounted during the installation at known positions. The pins will generate small verification echoes used for gauge verification at normal working pressure in the tank. The radar tank gauge can perform a verification test at any time without interfering with the normal liquid measurement. The result of the automatic verification should be presented at a service window of the diagnostic software embedded in the user interface.

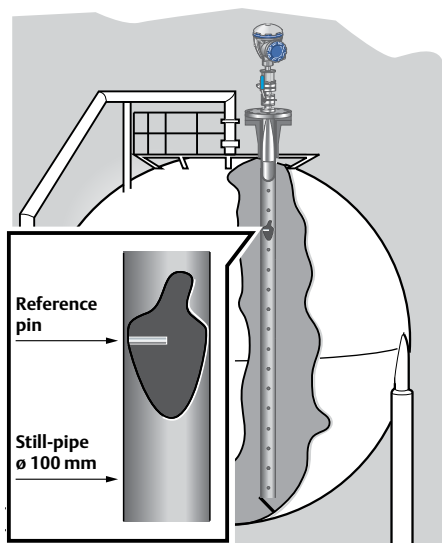

Figure 7.1: Level measurement in an LPG tank using a still-pipe with reference pins.

### 7.1 Radar tank gauging for LPG

The use of automatic tank gauging on pressurized tanks is described in API MPMS Chapter 3.3. Special considerations must be taken into account when designing radar tank gauges for pressure applications. Firstly, the unit must withstand the tank pressure and meet the safety standards written around pressure vessels. Secondly, the radar gauge must be manufactured so that it can effectively cope with the challenges that high vapor pressure may cause in such tanks. Thirdly, the radar tank gauge should have some means of performance verification during normal tank conditions.



Figure 7.2: A radar gauge for pressurized LPG tanks must cope with challenges caused by high vapor pressure.

Typical applications for this type of radar tank gauge are spherical and horizontal tanks used to store LPG or other liquefied gases.



Figure 7.3: Spherical and horizontal tanks used for storing LPG.

### 7.2 Radar tank gauging for LNG

The basic gauge design used for radar gauging on LPG tanks is also used on LNG tanks. Radar based tank gauging is today widely used for level measurement and overflow prevention in LNG storage tanks. This non-contact method with no moving parts offers advantages in terms of reliability and a less frequent need for maintenance. Radar is particularly suitable in LNG applications where in-tank maintenance is only possible at scheduled maintenance periods which have several year intervals. Also, the often long measuring distances in this application make non-contact measurement an attractive alternative. Today most LNG storage tank building projects have a preference for radar technology in level measurement and overflow prevention.



Picture 7.4: Still-pipe cluster inside an LNG tank.

A typical storage tank for LNG holds more than 50 000 m<sup>3</sup> representing a value of around USD15 million. Both from an economic, operational and safety aspect, the data measured by the tank gauging system has a large impact. A precision radar tank gauge delivers accuracy in the range of one millimeter over the entire tank height.

### 7.3 Typical system configuration

A typical radar based LNG tank gauging system with a configuration focusing on high reliability combined with high measuring performance can have the following main components:

- One primary high precision radar gauge for level measurement.
- One secondary high precision radar gauge for level measurement.
- Two (2) temperature transmitters, each with up to 16 spot temperature sensors for average liquid temperature measurement.
- A third radar gauge allocated for independent high level alarm. The gauge gives output to an alarm panel via SIL 2/3 rated relay or 4-20 mA signals.
- Transmitters and temperature elements for skin temperature measurement.
- A separate device for temperature and density profiling (LTD).
- Graphical field display.
- “Tank hubs” for data collection from field instruments and data transmission to the control room area.
- Data concentrators in the control room area for providing data to DCS systems, HMI systems and communication with general IT systems.
- LNG management software for operator interface and reports. The workstations are configured in a network for data distribution and increased redundancy.

The radar level gauge antenna for LNG should be designed for measurements on cryogenic liquefied gas. Radar signals are transmitted inside a 4-inch still-pipe which enables the gauge to have a sufficiently strong echo even under surface boiling conditions. The tank seal is equipped with a double block function, consisting of a quartz/ceramic window and a fire-proof ball valve. A reference device function enables measurement verification with the tank in service.



## 7 - Liquefied gases

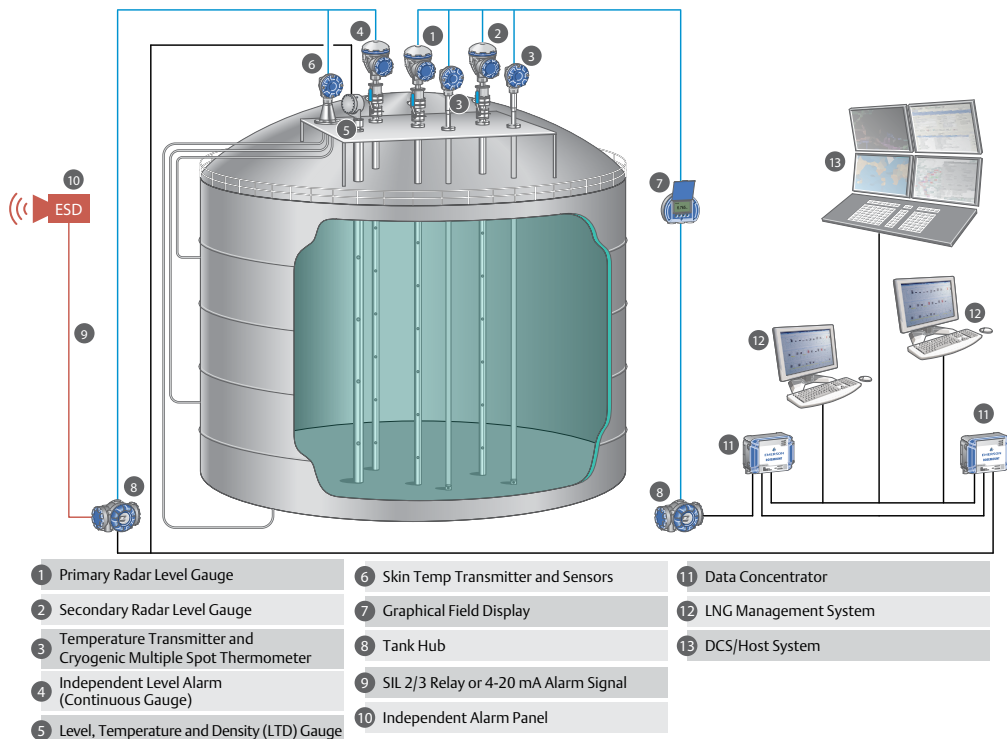

Figure 7.5: Example of a high performance LNG tank gauging system.

For land based LNG level measurement, the two most common types of gauges used today are mechanical servo gauges and radar gauges. The mechanical servo-operated gauge relies on a mechanical displacer attached to a wire on a drum. The displacer is lowered by the servo motor to the liquid and follows the surface movements. Intrusive gauging, many moving parts and a significant maintenance program are challenges connected with servo based gauging systems.

Safety and overfill prevention is a major concern for any tank facility used for bulk liquid storage of flammable liquids. Many of the first applications of radar on LNG was for independent overfill prevention, since the mechanical servo gauges used for regular level measurement did not meet the requirements. Today it is often required that the radar tank gauges have SIL 2 rated high level alarm capabilities. Multiple SIL rated radar gauges can be connected in a SIS loop so that voting between the high alarms is accomplished. It is also possible to utilize a 2-in-1 radar for the same purpose.

A typical instrument configuration on an LNG tank includes an LTD (Level Temperature Density) sensor. The LTD data is used by special software for roll over prediction. Roll Over is a phenomenon in a cryogenic tank that has the potential of causing large uncontrolled vapor emissions. By measuring the density and temperature profile the risk of a roll over can be predicted. Actions to mitigate the risk of roll over can then be initiated depending on the recommendations made by the software.



# 8

## Additional sensors

| Topic   | Page |
|---|------|
| 8.1 Density measurement and hybrid tank gauging_____  | 52   |
| 8.2 Pressure sensors used in hybrid tank gauging_____ | 54   |
| 8.3 Installation considerations_____                  | 54   |
| 8.4 Free water level measurement_____                 | 54   |



## 8. Additional sensors

For most tank gauging needs, level gauging and temperature measurements are sufficient to perform the required volume calculations. However, in many cases sensors are added for the measurement of observed density and free water level at the bottom of the tank.

### 8.1 Density measurement and hybrid tank gauging

A hybrid tank gauging system measures both level and pressure. The output from a pressure sensor is used in combination with the level value from the tank gauge. From these two variables, the observed density of the tank content can be calculated online. The API standard MPMS Chapter 3.6 describes the use of hybrid tank gauging and how the density is calculated.

In an open ventilated tank, with either a fixed or floating roof, only one pressure sensor is used (P1). If there is any pressure in the tank from blanketing or another source, a second pressure sensor (P3) is required.

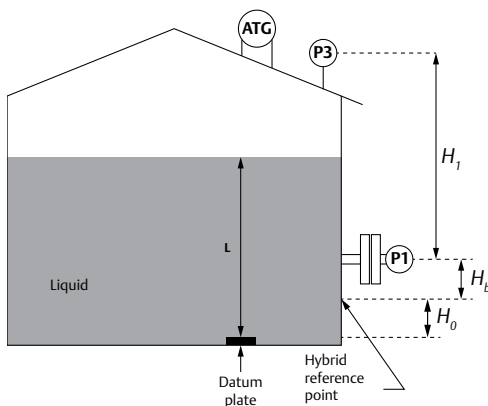

Figure 8.1: Density measurement is carried out with the help of a level gauge and one or two pressure sensors.

### Calculating observed product density,

#### 1. Observed Product Density ( $D_{obs}$ ) in vacuum

Hybrid density calculations are based on the fact that product density is proportional to the liquid pressure and can be calculated as below:

$P1 - P3 = \text{total liquid product head} + \text{in-tank vapor head} - \text{ambient air head between } P1 \text{ and } P3$

Head pressure in both liquid and vapor is approximately the same as the product of average density and head:

$\text{Liquid head pressure} = g \times (L - Y) \times D_{obs}$   
(at level of P1)

$\text{In-tank vapor head} = g \times [H_t - (L - Y)] \times D_v$   
(at surface of the liquid)

$\text{Ambient air head} = g \times H_t \times D_a$   
(at level of P1)

Then, the value of  $D_{obs}$  can be calculated from:

$$D_{obs} = \frac{N(P1 - P3) - g(D_v - D_a)H_t}{g(L - Y)} D_v$$

Where:

$D_{obs}$  = observed liquid density in vacuum

N = units constant

$Y = H_b + H_0$  (the vertical distance from P1 sensor to tank datum plate)

### mass in vacuum, mass in air and gross standard volume

L = ATG level (innage)

$H_b$  = vertical distance from sensor P1 center of force to the hybrid reference point

$H_0$  = vertical distance from the tank datum plate to the hybrid reference point

g = local gravitational acceleration

$H_t$  = vertical distance from P1 to P3 diaphragms centers of force

$D_v$  = in-tank vapor density

$D_a$  = ambient air density

**Note:** If the hybrid reference point is at the same elevation as the tank datum plate,  $H_0$  is zero.

#### 2. Product Mass Calculation in vacuum (M)

$$M = GOV \times D_{obs} - WR$$

Where:

GOV = Gross observed volume

$D_{obs}$  = Observed product density (in vacuum) from 1.

WR = Floating roof mass (if applicable)

**Note:** In atmospheric storage tanks, the mass of product in vapor can be set to zero.

#### 3. Product Apparent Mass in Air ( $M_a$ )

$$M_a = M \left( 1 - \frac{D_a}{D_{obs}} \right)$$

Where:

M = Total product mass (in vacuum) from 2.

$D_a$  = Ambient air density

$D_{obs}$  = Observed liquid density (in vacuum) from 1.

#### 4. Gross Standard Volume (GSV)

$$GSV = GOV \times VCF$$

Where:

GOV = Gross observed volume

VCF = Volume correction factor, typically obtained from MPMS Chapter 11.1, ASTM D-1250

### 8.2 Pressure sensors used in hybrid tank gauging

The accuracy of the calculated Observed Density is dependent on the performance of the pressure sensors used. Due to the pressure sensor characteristics, the density accuracy varies over the level span in the tank. The highest density accuracy is achieved at high liquid levels. The accuracy is reduced when the tank level is close to the P1 sensor. There is a certain cut-off level, meaning that density measurements are inhibited below this point.

Only the most accurate pressure sensors should be used for hybrid tank gauging. The accuracy required is in the range of 0.035% of span.

The water level sensor is an interface sensor which determines the line between the water and the hydrocarbon above it, which can be a very challenging task. In tanks with refined white oils, the cut between the water and oil is often well defined and easy to measure, but in tanks with black oils or crude oil the interface tends to be an area of emulsion, making the cut hard to define.

Capacitance based water level sensors are normally used in combination with the other components of a tank gauging system. The capacitance sensor is normally integrated with the temperature sensor. This enables the combined level/temperature sensor unit to be installed in only one tank aperture sized 50 mm (2 in.) or larger.

### 8.3 Installation considerations

To gain the best range and accuracy, the P1 sensor should be located at a point as low as possible in the tank. However, the location must not be so low that interference from free water and sludge will cause measurement problems. Typically the P1 sensor is mounted at a level between 0.5 and 1 meter from the tank bottom. The pressure sensor should also be installed with a block off valve in such a way that the sensor can be removed and serviced.

The P3 sensor is located at the top of the tank above the highest liquid level.

### 8.4 Free water level measurement

Petroleum storage tanks may accumulate water in the bottom. Sources of this water may be condensation of air moisture entering vents as the tank is emptied or rain water accidentally entering the tank. There may also be water ingress into the product before the tank is filled. This is common for crude oil tanks and may pose problems if the water level gets too high. To avoid this, the free water must be drained from the tank. As a general rule, water content should be kept as low as possible.

To keep track of the free water level, sensors connected to the tank gauging system are utilized wherever required. The free water level data is also used in the inventory calculation to achieve proper product volume assessments.

# 9

## System architecture

| Topic                        | Page |
|------------------------------|------|
| 9.1 Tank wiring              | 58   |
| 9.2 Tank farm field buses    | 58   |
| 9.3 Communication redundancy | 58   |
| 9.4 Bridge solutions         | 59   |
| 9.4.1 Gauge emulation        | 59   |
| 9.4.2 Wireless communication | 59   |
| 9.5 Software                 | 60   |



## 9. System architecture

The main purpose of the system architecture of a tank gauging system is to route the tank information from the tank farm to the users in a fast and reliable manner.

Legacy tank gauging systems based on float and servo gauges all use proprietary communication networks. In the past, different manufacturers of gauging systems used separate and incompatible field bus networks, communication interfaces and protocols. Users of these systems were stuck with a single supplier of tank gauging equipment during the entire life of the system. This in combination with using mechanical gauges that required maintenance, repair and supply of parts in many cases generated a high cost of ownership.

Modern tank gauging systems use open architectures and standardized communication protocols. A user of these systems will not be locked into a single source situation and will have many options when selecting instruments.

There are now “bridge solutions” that allow legacy systems to be modernized step by step. Gauge emulation and wireless technology are two such bridges.

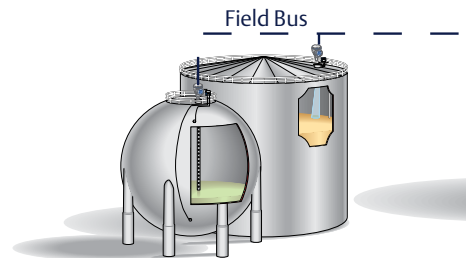
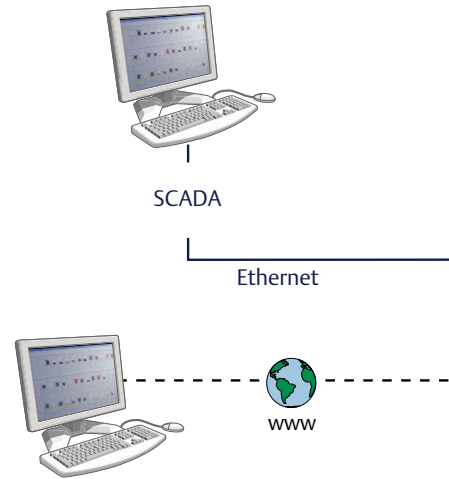

## 9 - System architecture

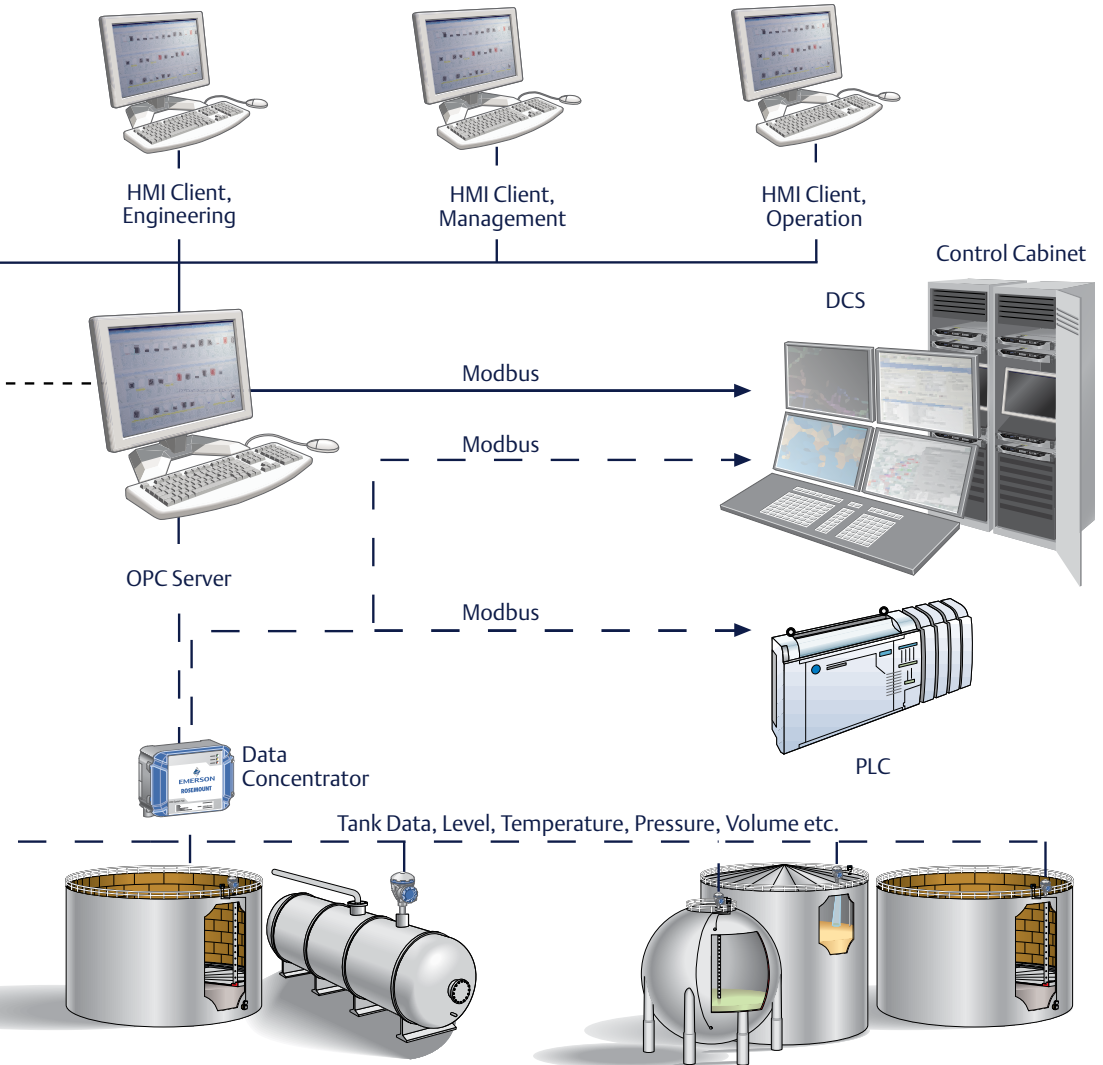

Figure 9.1: Modern tank gauging system architecture.

### 9.1 Tank wiring

The instruments on the tank need power and a link to the control room. This is in most cases best realized through a local intrinsically safe instrument field bus. Using intrinsically safe wiring on the tank offers safety benefits. It also saves installation cost as no expensive cable conduits are required. The tank bus is normally connected and powered through a tank side communication/power unit. From here the longer runs of the tank farm field bus are connected and so is the local power supply. Wireless communication can also be located from here.

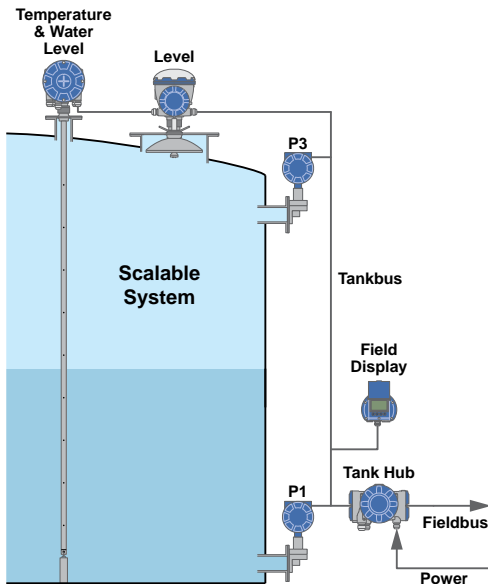

Figure 9.2: Intrinsically safe field bus providing power and communication to the tank units.

### 9.2 Tank farm field buses

The process variables measured by the tank devices must reach users of this information quickly and with high integrity. The devices are spread over a large area in the tank farm and field bus wiring can run long distances. The wiring has to sustain challenges such as attenuation and lightning damage. Existing wiring is often in place and it should be possible to use this wiring when installing a new tank gauging system since new signal wires are expensive to install. If no signal wiring exists or is in bad condition, wireless communication can bridge these gaps.

### 9.3 Communication redundancy

Tank information availability is of utmost importance for the operation of a busy tank farm. Lack of tank information can quickly shut down tank farm oil movements.

To establish high information availability, different redundancy solutions can be applied. They include:

- Gauging redundancy by using more than one gauge per tank
- Field bus redundancy by using multiple or different communication layers for the field buses
- Gateway redundancy with redundant wires and wireless gateways
- Network switch and network redundancy
- User interface redundancy



Figure 9.3: Tank redundancy is accomplished with dual tank gauges and separated communication layers - wired and wireless.



## 9.4 Bridge solutions

Migration from an old legacy system to a new system can be difficult to accomplish apart from replacing the entire system in one single major project. Old proprietary field buses often pose a major obstacle for a gradual upgrade. However there are ways to overcome this block and bypass the legacy systems:

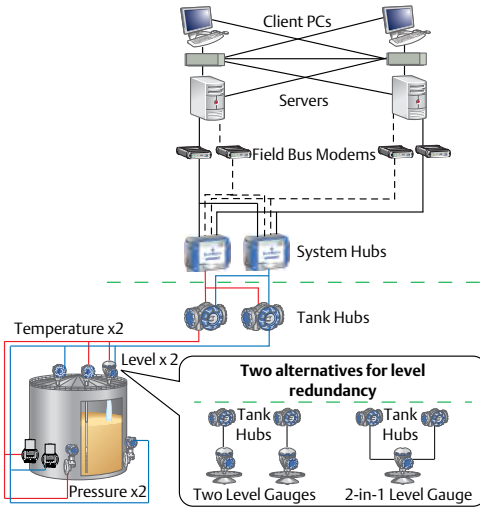

Figure 9.4: Different layers of redundancy: Tank unit redundancy and field communication unit redundancy combined with redundant data servers and operator stations.

### 9.4.1 Gauge emulation

An easy way to replace old tank gauges in existing field bus infrastructures is by making new gauges emulate the old ones by communicating via the old field bus and use the same communication protocol and the existing power supply. With this “gauge emulation” an old gauge can be quickly replaced with a new one based on different technology. There are no changes of the field buses or control room equipment required. Gauge emulation can also be implemented in combination with wireless solutions.

### 9.4.2 Wireless communication

Wireless instrument communication is far from new. However it is only recently that intelligent self-configuring mesh networks have been applied for telemetry. Mesh networks as described by the standard IEC 62591 or *WirelessHART*® are very suitable for use in tank gauging systems. They have in recent years become an attractive solution to build system architectures both for tank gauging and other types of instrumentation. Wireless communication can greatly reduce tank gauging installation cost.

One important characteristic of a self-configuring mesh network is that a minimum of engineering effort is needed to design the system. Following simple guidelines covering node distances and

Tank Gauging servers are often placed in rack rooms or control rooms. Customized cabinets house the servers and the field gateways.



Figure 9.5: A tank gauging system cabinet.

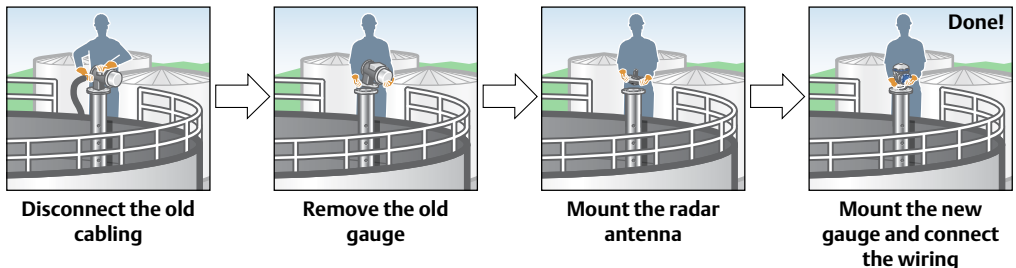

Figure 9.6: With gauge emulation, a tank by tank upgrade is easy.

locations of gateways, the system layout can be designed within an hour. After power up, the network establishes itself and will be ready for operation in a few minutes. Due to multiple communication paths the network is self-healing if any link is disabled. Data encryption and frequency hopping enables high levels of data security and communication reliability. A tank gauging system that can communicate both through wires and wirelessly has the potential of enhancing data availability even further through communication diversity and redundancy.

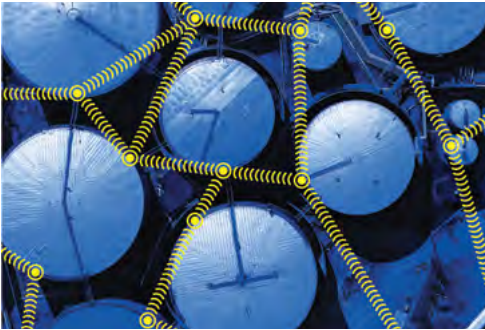

Figure 9.7: A self-organizing mesh field network can automatically find the best way around any fixed or temporary obstacles.

### 9.5 Software

A tank gauging system is not complete without a versatile software package that brings all the tank information together. The tank gauging computer system conducts numerous tasks and many of these must be done under certain specific standards and regulations to cover bulk liquid storage operations. The software should also provide aid for tasks including batch control and storage planning.

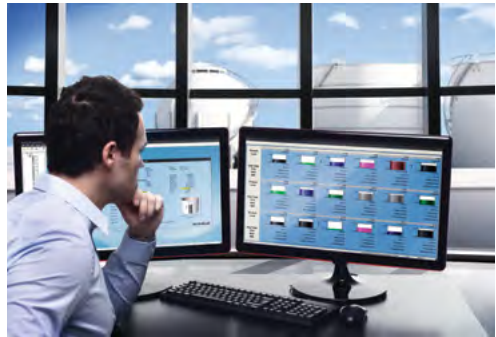

Figure 9.9: Tank gauging software.



Figure 9.8: Antenna connected to tank devices.

The software requires a comprehensive and user friendly HMI built for tank farm operators. Reliability and safety are key properties of the HMI since it plays a large part in the different layers of operational safety. Navigation between the functions and the tanks should be easy and fast.

Functional requirements of a tank gauging information system can be summarized as follows:

#### Display of real time tank data

Operators need full control over the tank farm operations at all times. Levels and level rates must be displayed without any significant latency.

#### Volume and mass calculations

The tank gauging software must quickly and accurately calculate tank inventory data. The volume calculations should follow the relevant API standards and other standards/methods suitable for different bulk liquids. The software must be able to handle different types of volume tables (strapping tables) with a large number of data points.

### Handling of laboratory product data

It is necessary to use liquid product data from lab samples such as density and water content. The software should have the capability to use such data either via direct input from the lab systems or by manual operator entry.

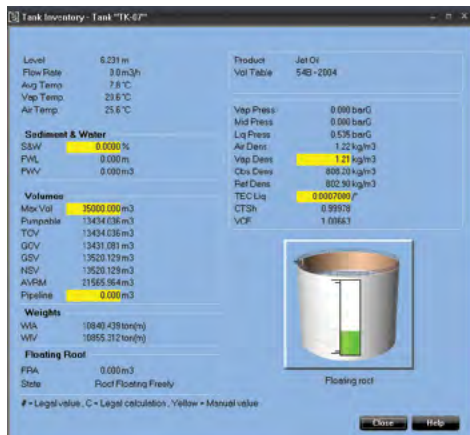

Figure 9.10: A tank information window of a tank operator station.

### Reporting

Stored bulk liquids generally represent a substantial value and the assessment of the stock needs to be reported accurately and at the desired frequency. The reports should be customized to the user requirements and be presented at given points in time. Example reports are: Inventory reports, Mass balance reports, Shift Reports and Event Log Reports.

Reports can be stored, printed, e-mailed or sent to other software through OPC or other network based transmission methods.

### Alarm handling

Tank gauging is the first layer of defense against overfills. The HMI must be able to provide operator alarms if any set level or other variables are reached. Both fixed and adjustable points are required. Alarms should be audible and visible, and able to be distributed over the plant network, by e-mail and to cellphones. Alarms and alarm acknowledgements should also be logged, stored and reported.



### Historical data

Operators should be able to access historical data for reliable follow up and review of past events. Presentation of data should be in numerical and graphical modes.

### Embedding and integration

Direct and derived tank data are distributed through embedding and linking to other office and enterprise software.

### User Management

Tank gauging management software requires proper handling of user management. User login and logout, user access rights and logging of such events and alarm acknowledgements should be provided for safety reasons.



Figure 9.11: Tablets can be used to check tank gauging data.

### **Connectivity to other systems**

Besides data distribution within the tank gauging server and its clients, the tank data should also be easily distributed to other high level systems. Data distribution through an embedded web server will enable data distribution to clients within and outside the plant network.

Another important communication capability is connection to legacy tank gauging systems. In a large plant such as a refinery there may be groups of tank gauges of different makes. The tank gauging software should have the capability to communicate and control such systems and make it a source of tank gauging information for the entire tank farm.

### **Configuration and trouble shooting**

The tank gauging software is often the tool for configuration, installation and trouble-shooting of the entire tank gauging system. It should be made such that every system can be configured at the site by local engineers or operators. Trouble shooting is ideally carried out in the control room to minimize tank climbing. A good tank gauging software with automatic “wizard based” configuration and service tools makes this possible.

# 10

## Overfill prevention

| Topic                                      | Page |
|--|------|
| 10.1 What's at stake_____                  | 64   |
| 10.1.1 Probability_____                    | 64   |
| 10.1.2 Consequence_____                    | 64   |
| 10.2 Benefits_____                         | 65   |
| 10.3 Industry standards_____               | 65   |
| 10.3.1 API 2350_____                       | 66   |
| 10.3.2 IEC 61511_____                      | 66   |
| 10.4 Modern overfill prevention_____       | 67   |
| 10.4.1 Key elements_____                   | 67   |
| 10.4.2 Traditional approach_____           | 67   |
| 10.4.3 Modern approach_____                | 68   |
| 10.4.4 2-in-1 tank gauging technology_____ | 69   |
| 10.4.5 Proof-testing_____                  | 70   |

# 10. Overfill prevention

Tank overfills have for a long time been one of the leading causes of serious safety incidents at bulk liquid storage facilities, but overfills do not occur randomly. They are predictable and therefore preventable. This chapter summarizes current knowledge and expertise on tank overfill prevention and how modern equipment can be used to reach closer to the goal of zero tank overfills. Additional in-depth reading can be found in “The Engineer’s Guide to Overfill Prevention” (ISBN 9789198277906).

## 10.1 What’s at stake?

Risk consists of two components: probability and consequence. Both of these components are unusually large for tank overfills compared to other potential risks at a tank farm.

### 10.1.1 Probability

Historical industry data indicates that statistically one overfill occurs every 3,300 fillings, according to an independent insurance company ([Marsh and McLennan Companies, 2011](#)).

### 10.1.2 Consequence

This section provides information about example consequences that can occur from a tank overfill using specific case examples.

### Spill clean-up

*Western Massachusetts, United States, 2005*



*Figure 10.2: Spill clean-up in Western Massachusetts.*

Small facility with a single operator present while a bulk liquid storage tank was filled through a pipeline. The operator thought that he would have time to go to the bar across the street for a quick beer. Suddenly the bartender points out that diesel is shooting out from a tank vent. 23 000 gallons of diesel were released to the secondary containment which consisted of soil bottom and steel sides. 14 000 gallons of the released product were recovered using vacuum trucks and 9 000 gallons were lost to the subsurface which contaminated the groundwater. Light non-aqueous phase liquid was found in 14 wells during 2 weeks. More than 300 000 gallons of liquids were extracted and reinjected to recover the soil in the vicinity of the tank. Total cost exceeded \$350 000.



*Figure 10.1: Property damage after the accident at Buncefield.*

### Injuries, property damages and corporate fines

*Buncefield fuel depot, United Kingdom, 2005*

A floating-roof tank overfilled at a tank terminal which resulted in the release of large quantities of gasoline near London. A vapor cloud formed which ignited and caused a massive explosion and a fire that lasted five days. The primary root cause was that the electromechanical servo level gauge failed intermittently and the mechanical level switch used in the independent overfill prevention system was inoperable.



### Bankruptcy

Puerto Rico, United States, 2009



Figure 10.3: Puerto Rico accident in 2009.

During the off-loading of gasoline from a tanker ship to the tank farm, a five million gallon above ground storage tank overfilled into a secondary containment dike, resulting in the formation of a large vapor cloud which ignited after reaching an ignition source in the wastewater treatment area of the facility. In addition to causing an extensive vapor cloud fire, the blast created a pressure wave registering 2.9 on the Richter scale. For more than two days, dark clouds of particulates and smoke polluted the air, and petroleum products leaked into the soil and navigable waterways in the surrounding area.

## 10.2 Benefits

Investment in modern overfill prevention is good business because not only does it reduce the statistically high risk of a tank overfill but it also has an immediate positive financial impact. By better knowing what's in the tank, both efficiency and tank utilization can be increased.

### Why invest in modern overfill prevention?

- Protect life and health
- Protect environment
- Protect plant assets

- Comply with regulations
- Improve public relations
- Corporate social responsibility
- Increase plant efficiency
- Minimize financial and legal risks

### Example 10.1: tank terminal capacity expansion (fictional)

A tank terminal, which currently has 10 tanks, needs to expand its capacity. Currently, the normal fill level is 80%. A pre-study determined that by investing \$15 000 per tank in better overfill prevention, the normal fill level can be increased to 90%. For all tanks, the cost equates to \$150 000 and the addition of 10 percentage points per tank corresponds for the 10 tanks to an additional space of one tank. As a comparison, the alternative equivalent cost of building a new tank was estimated to exceed \$1 m.

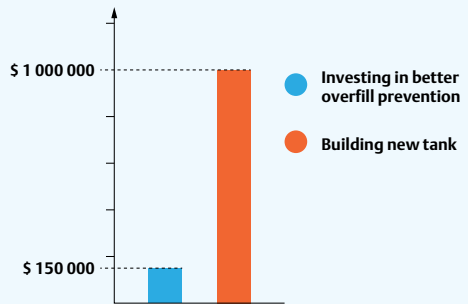

Figure 10.4: Comparison of two investment options that both correspond to an increase in volume equivalent to one tank.

## 10.3 Industry standards

There have been significant advancements in the understanding of tank overfill root-causes in recent years due to the increased availability of information. Modern overfill prevention is based on the understanding that a multitude of elements contribute to minimizing the risk of a tank overfill. This has been the basis for the two globally

# 10 - Overfill prevention

recognized industry standards for modern overfill prevention: [IEC 61511](#) and [API 2350](#).

IEC 61511 and API 2350 have different scopes. API 2350 is an application specific standard specifically for bulk liquid storage, whereas IEC 61511 is targeted towards the design of electronic safeguards in both the process and bulk liquid storage industries.

### 10.3.1 API 2350

API 2350 concerns “Overfill Protection for Storage Tanks in Petroleum Facilities” and provides a holistic perspective on modern overfill prevention. It addresses both “soft” factors such as procedures and documentation as well as “hard” factors such as equipment and location of alarm points.

The standard requires modern facilities (denoted as “Category 3”) to be equipped with an Automatic Tank Gauging (ATG) system and an independent Overfill Prevention System (OPS). API 2350 accepts both Manual Overfill Prevention Systems (MOPS), where human intervention is required to prevent overfill, as depicted in figure 10.5 and Automatic Overfill Prevention Systems (AOPS) as depicted in figure 10.6, although the latter is preferred. In the case of an AOPS, the practical requirement is that it should be designed according to IEC 61511.

### 10.3.2 IEC 61511

IEC 61511: “Functional safety – Safety instrumented systems for the process industry sector” is a standard for Safety Instrumented Functions (SIF; sensor, logic, actuator) such as automatic overfill prevention systems (AOPS). The reliability of a SIF is quantified in “Safety Integrity Level” (SIL) 0 – 4, which each corresponds to an interval of its capability to reduce risk, as listed in table 10.1.

| Safety Integrity Level (SIL) | Minimum Risk Reduction Factor (RRF) |
|------------------------------|-------------------------------------|
| SIL 3                        | 1000                                |
| SIL 2                        | 100                                 |
| SIL 1                        | 10                                  |

Table 10.1: Overview Safety Integrity Levels (SILs) and corresponding risk reduction factors (RRFs)

The standard does not prescribe the usage of a specific SIL; The required risk reduction shall be determined based on a risk assessment for the specific application.

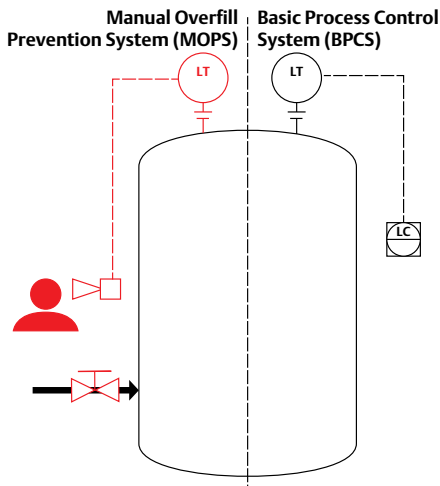

Figure 10.5: MOPS usually consists of a level transmitter (LT) connected to an audiovisual alarm that notifies an operator to take the appropriate action, e.g. closing a valve.

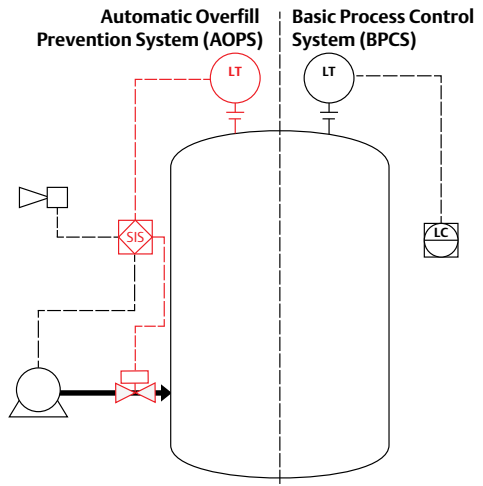

Figure 10.6: AOPS usually consists of a level transmitter (LT), logic and actuator which automatically closes a valve to prevent overfills from occurring. The logic may also execute non-safety critical tasks such as shutting down a pump and notifying operators through audiovisual alerts.



## 10.4 Modern overfill prevention

Modern overfill prevention is based on a holistic perspective with an understanding of the fact that a multitude of elements contribute to minimizing the risk of a tank overfill, and not just the equipment denoted as the ‘overfill prevention system’.

### 10.4.1 Key elements

Key elements of modern overfill prevention include:

- Conducting a Risk Assessment
- Following procedures documented in an Overfill Management System
- Education
- Use of appropriate equipment
- Non-adjustable alarm points
- Appropriate commissioning procedures such as Site Acceptance Testing (SAT)
- Periodic maintenance and proof-testing
- Management of change

The accepted view-point is that best practice is to use a number of independent protection layers to prevent an accident from occurring, i.e. “to not put all eggs in the same basket”. In the case of overfill prevention, the typically used protection layers are depicted in figure 10.7.

One of the most overlooked elements of overfill prevention is probably the Automatic Tank Gauging (ATG) system. This is the primary independent protection layer that continuously prevents tank overfills from occurring. When the ATG system functions correctly, the other protection layers will not be activated. Therefore it may be argued that this is the most important protection layer and as a consequence it needs to receive appropriate attention. For example an ATG system relying on an unreliable mechanical level transmitter is not just an operational inconvenience but also a major safety concern.

### 10.4.2 Traditional approach

In the past, an overfill prevention system was usually based on point-level solutions. This equipment was often put in place to fulfill incomplete prescriptive regulatory requirements and was treated accordingly. Capital expenditure was minimized and maintenance and verification were not prioritized.

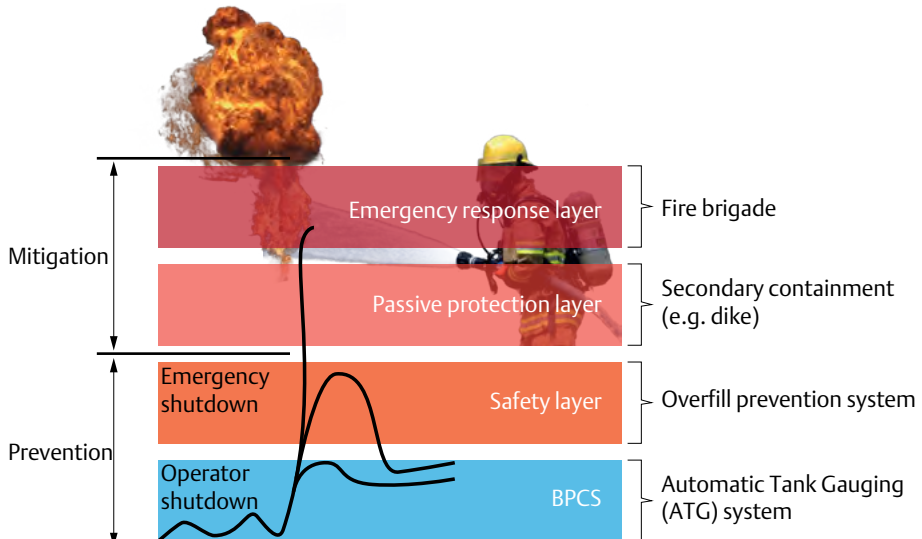

Figure 10.7: Commonly used independent protection layers to minimize the risk of tank overfills.

# 10 - Overfill prevention

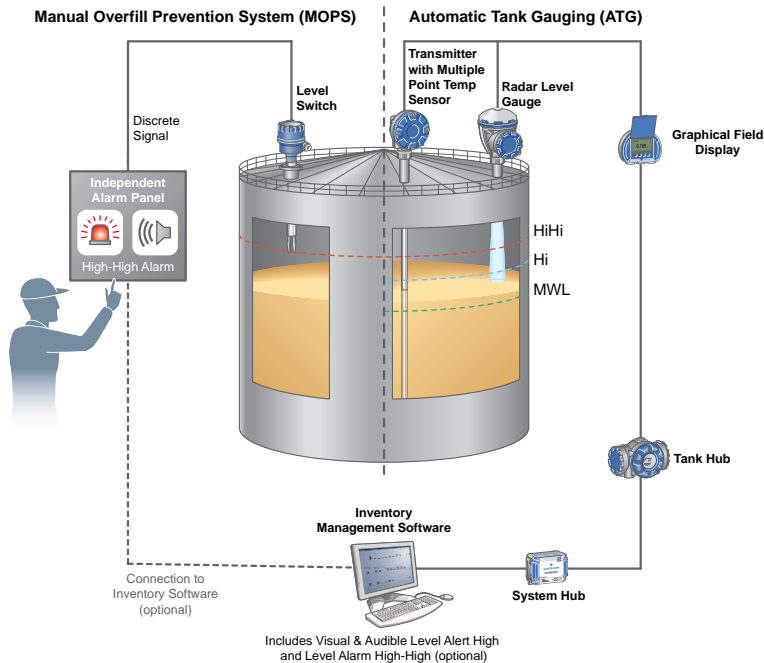

Figure 10.8: The traditional (obsolete) approach to overfill prevention - manual systems based on point-level measurement.

## 10.4.3 Modern approach

The industry has rapidly moved towards a modern approach which is based on an automatic overfill prevention system (AOPS) with continuous level measurement. The advantages are both financial and risk reduction:

- Humans are inherently unreliable. The risk of an overfill can be reduced by using an automatic system.
- It is difficult to know whether a point-level sensor functions correctly and it therefore requires frequent proof testing.
- A deviation alarm between the OPS and ATG level sensor can be used to verify the integrity of both systems.
- A single continuous level sensor can be used for multiple alarms and alerts such as High-High, High, Low, Low-Low. It is not unusual that a single continuous level sensor replaces 4 separate point-level sensors.

- Continuous level measurement allows for adjustment of alarms and alerts.

In practice, identical level sensors are often used for both OPS and ATG as shown in figure 10.9. This approach is usually selected because:

- The OPS level sensor can act as backup in case the ATG fails and thereby minimizes downtime.
- It reduces the need for device specific configuration tools and education
- Inventory of spare-parts is minimized.
- Contrary to a common perception, neither API 2350 nor IEC 61511 requires the use of different technologies for OPS and ATG level sensors (technology diversification).

Why select anything but the best also for the OPS level sensor?

# 10 - Overfill prevention

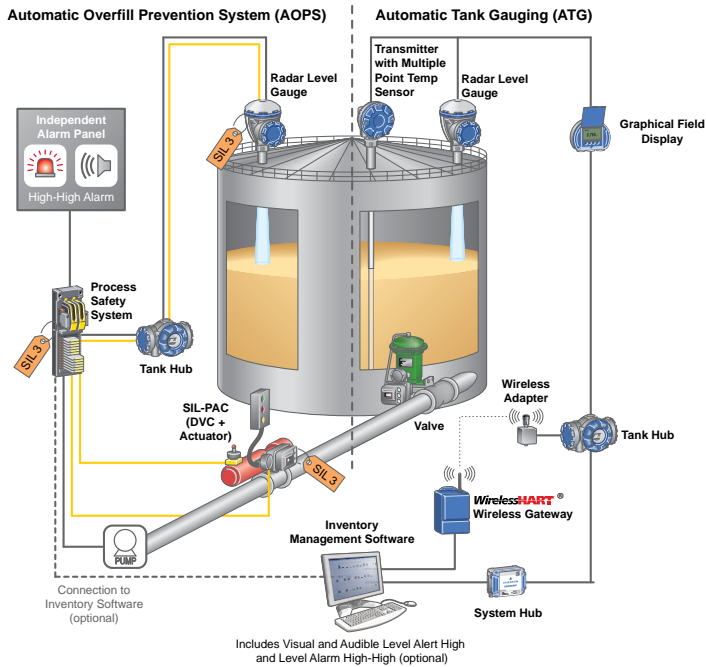

Figure 10.9: Example of a modern approach incorporating an automatic overfill prevention system based on continuous radar level measurement.

## 10.4.4 2-in-1 tank gauging technology

Mechanical installation of an independent OPS level sensor is sometimes prohibitive due to cost, especially when requiring an additional measurement pipe in a floating roof tank. Therefore the most recent advancement in level sensor technology is a 2-in-1 radar level measurement as depicted in figure 10.10.



Figure 10.10: 2-in-1 radar level gauge.

2-in-1 radar level gauges can be used simultaneously for Automatic Tank Gauging (ATG) and independent OPS level measurement as shown in figure 10.11.

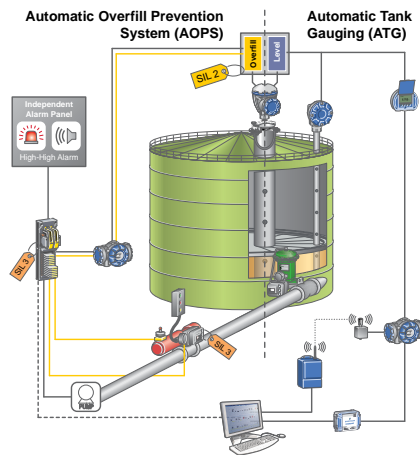

Figure 10.11: System overview for 2-in-1 radar level measurement.

The usage of 2-in-1 radar level gauges is based on the foundation that the antenna has a very low failure rate in comparison with the electronics. The antenna is a non-moving mechanical part with approximately the same Mean Time Between Failures (MTBF) as the tank itself. Therefore it has been verified by independent accredited third parties to be compliant with both IEC 61511 and API 2350.

### 10.4.5 Proof-testing

The purpose of proof-testing is to detect random hardware failures to verify that commissioned equipment already in operation functions correctly. It is a critical procedure to maintain the integrity of the OPS-system and it should therefore be executed periodically. API 2350 prescribes every 6 months for point-level and every 12 months for continuous level unless a device specific calculation is performed.

The traditional approach is a 'bucket-test' as depicted in figure 10.12. This method requires a visit to the tank and access to the level sensor while the tank is temporarily taken out of operation. The procedure may be a direct safety concern to the personnel executing the test since it both exposes the tank to the atmosphere and the bucket contents may be hazardous.

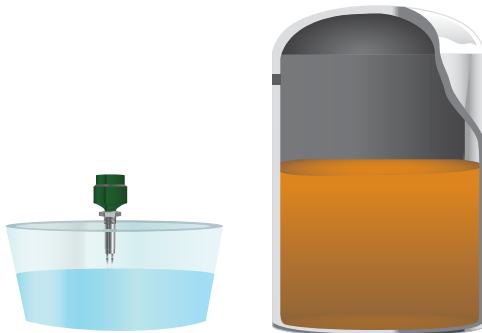

Figure 10.12: Traditional approach to proof testing - bucket testing.

With modern continuous level measurement sensors, the proof test can be executed remotely from the control room in a few minutes. Additionally, reports can be generated automatically and the proof test interval can often be extended. This reduces labor and the tank's down-time, but more importantly, it reduces the overall risk.



## Appendix: Typical tank gauging configurations

| Topic                              | Page |
|------------------------------------|------|
| A.1 Tank types                     | 72   |
| A.2 Wireless                       | 76   |
| A.3 Emulation                      | 78   |
| A.4 Redundancy                     | 82   |
| A.5 Overfill prevention            | 83   |
| A.6 Rosemount™ Tank Gauging System | 84   |



# Appendix: Typical tank gauging configurations

## A.1 Tank types

### Fixed roof tank

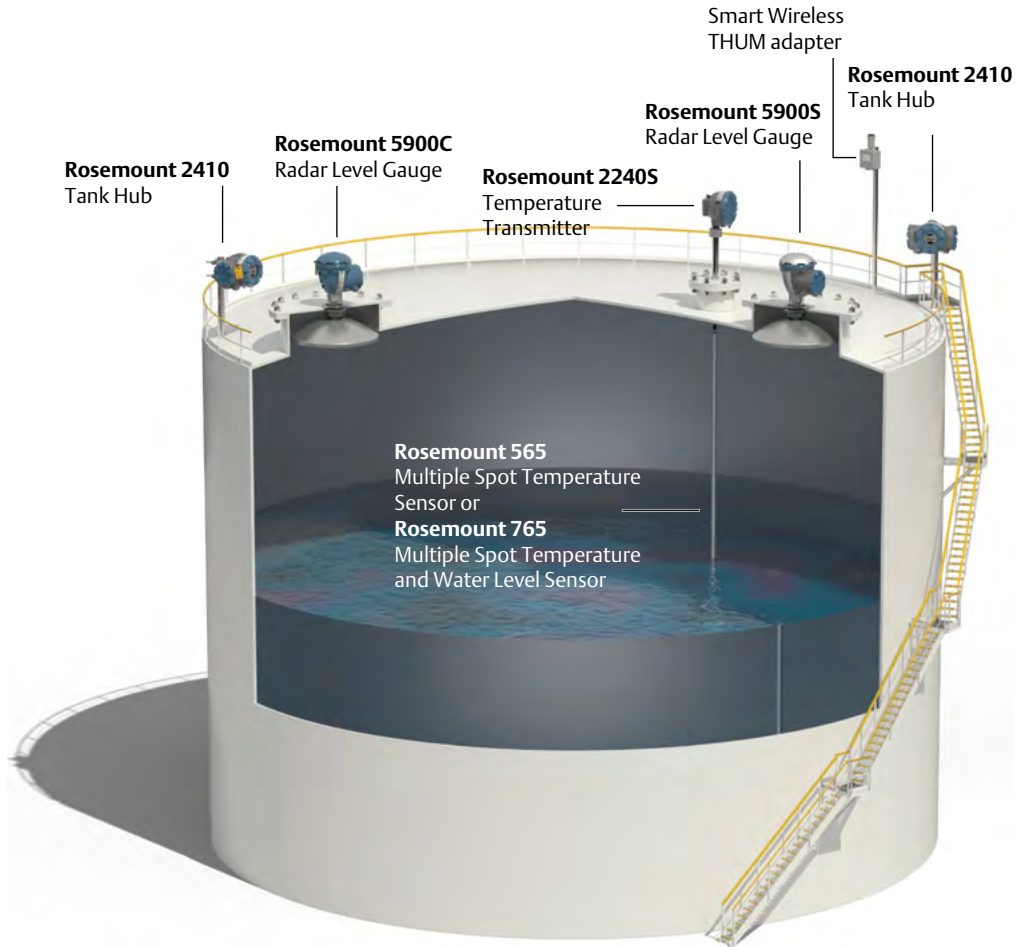

### Floating roof tank

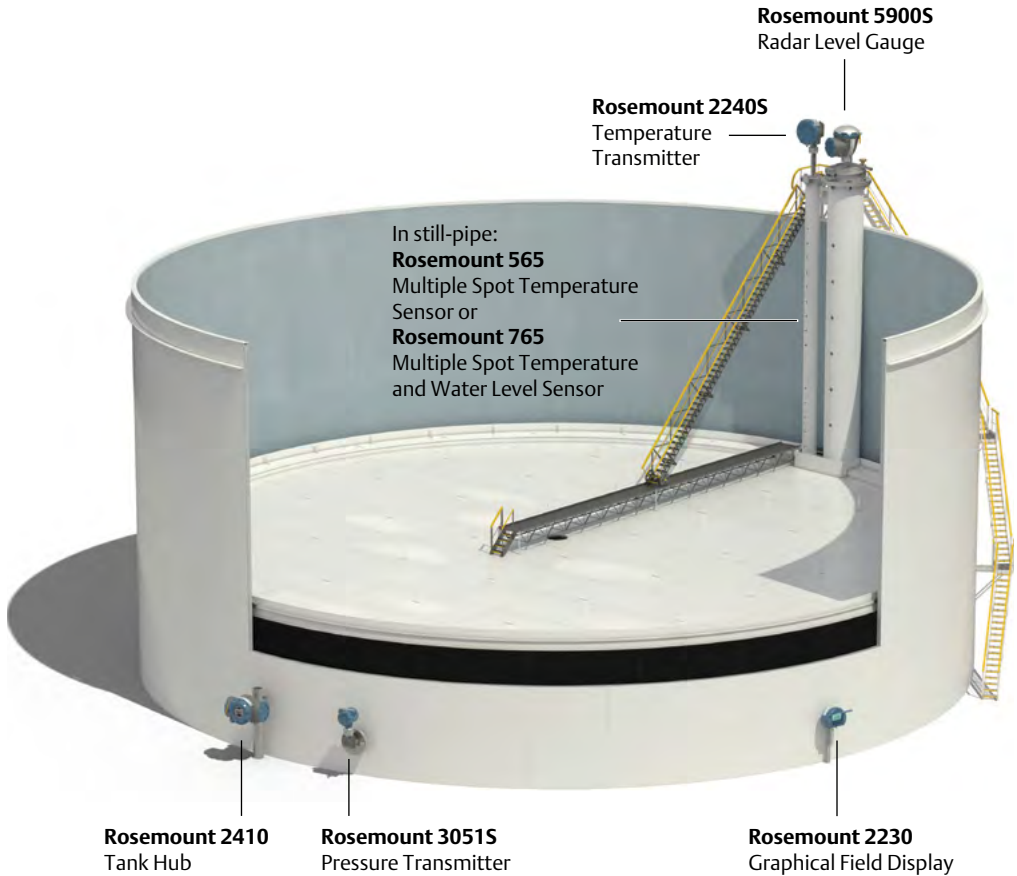

### Pressurized spherical tank





### Pressurized horizontal tank

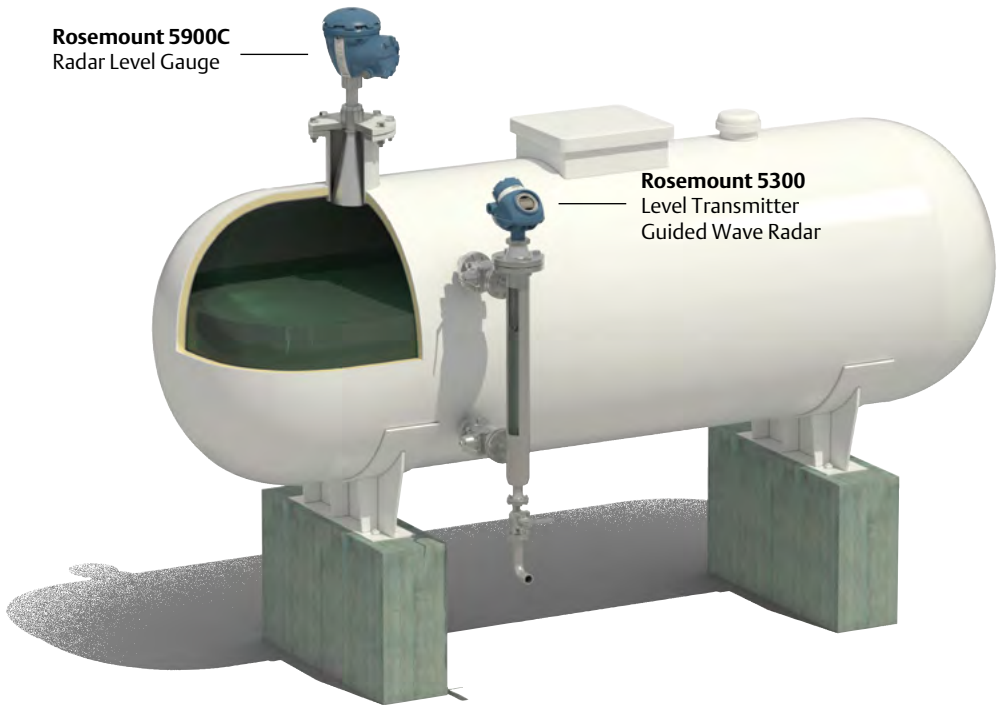

## A.2 Wireless

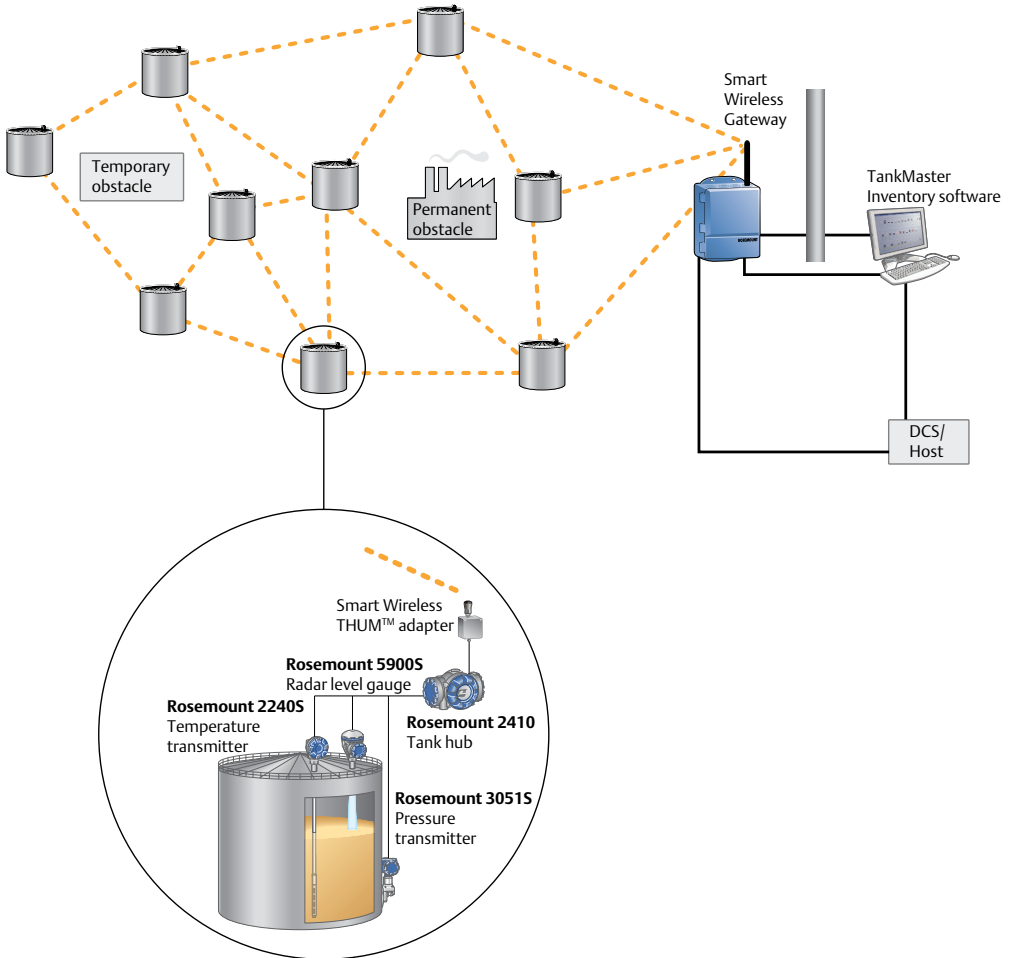

All wireless devices communicate with the host system through the Smart Wireless Gateway. A Rosemount Tank Gauging System can consist of both wired and wireless networks.

## Wireless system architecture

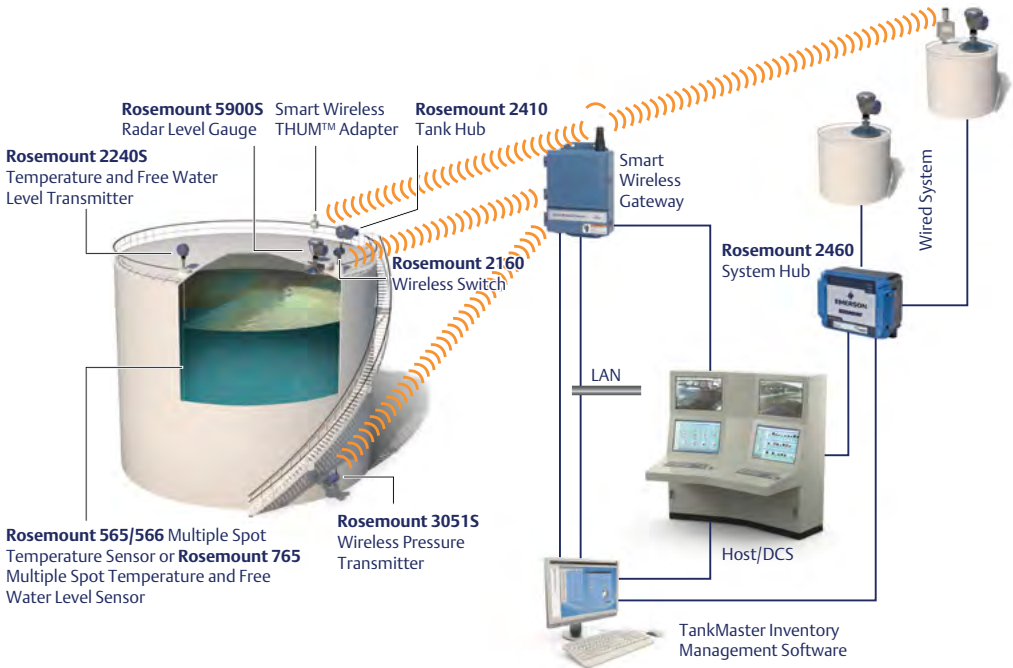

A Smart Wireless tank gauging solution designed specifically for every customer's bulk liquid storage plant maximizes safety and operational performance.

## A.3 Emulation

### Gauge emulation

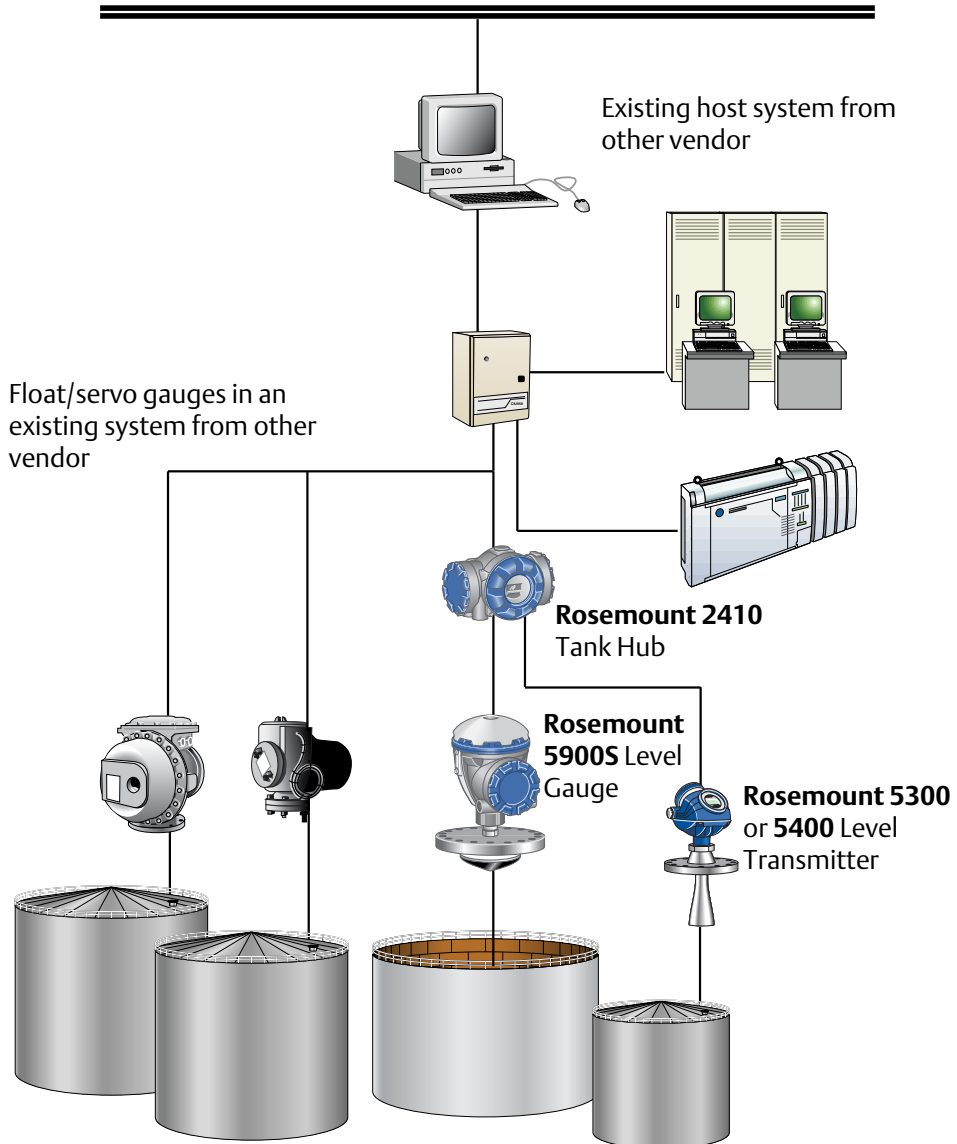

A Rosemount device can seamlessly replace a gauge from other vendor, independent of measurement technology. Data from the tank is displayed as before on the existing inventory management system.

## Tank management system replacement

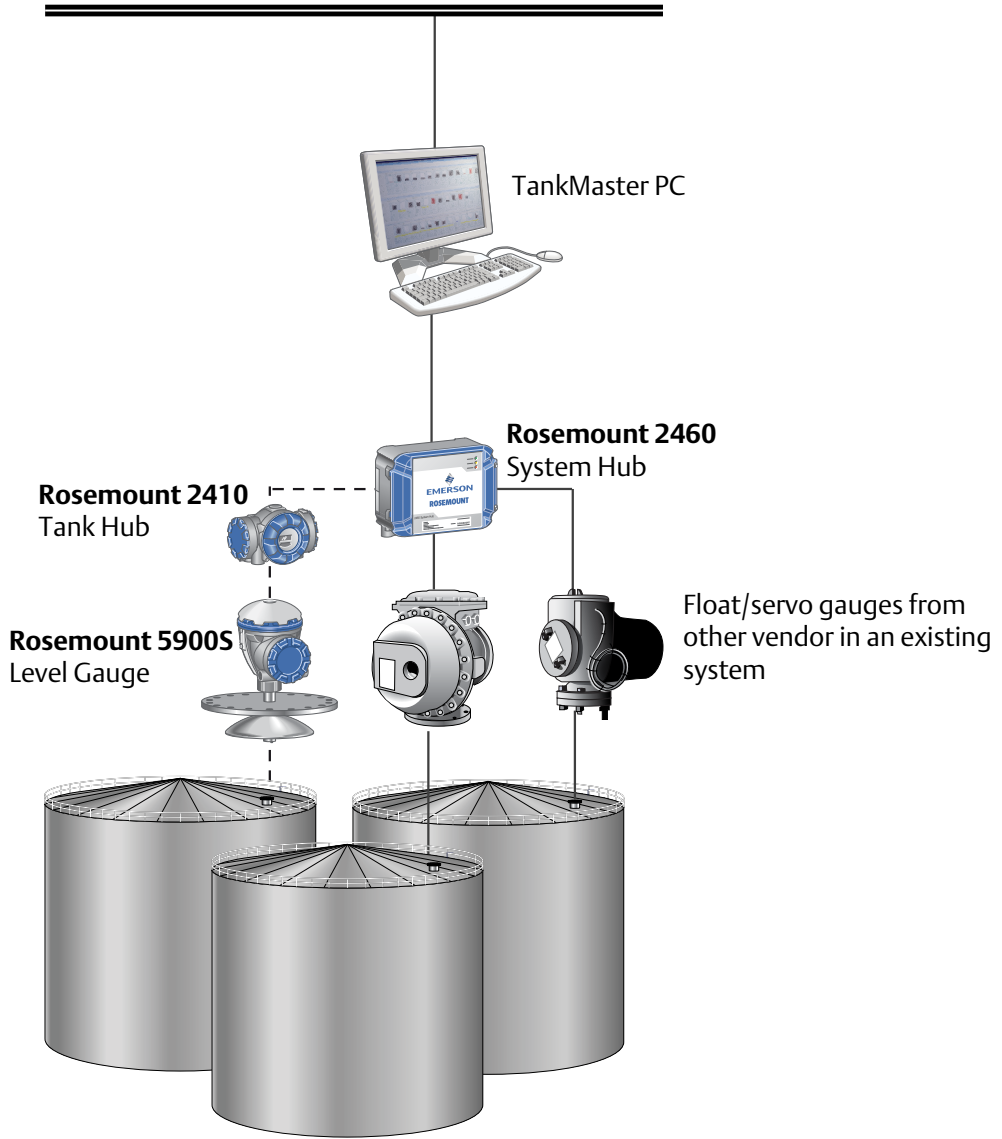

Replacing old tank monitoring software with TankMaster.

## Bridge solutions

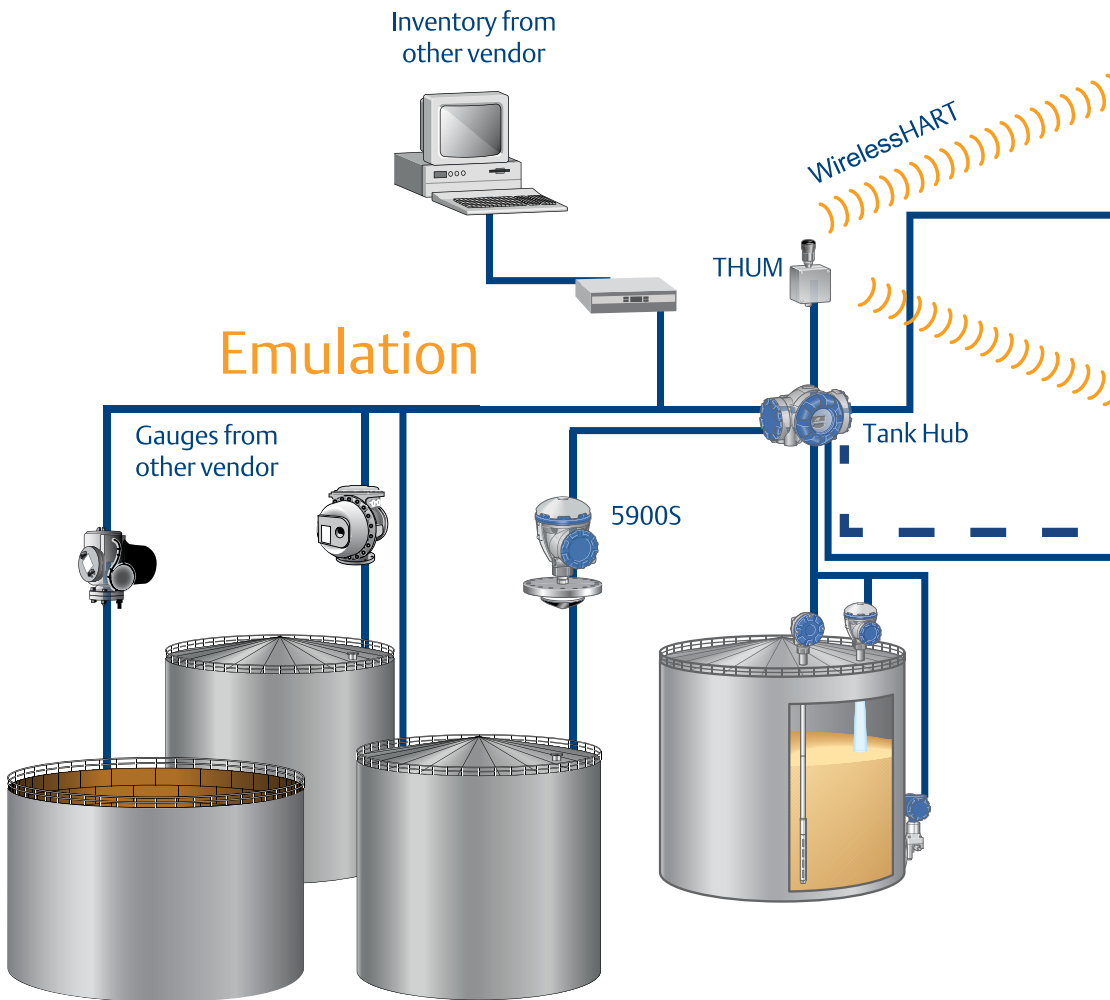

Adding a wireless network can bridge the gaps of the legacy bus system. By doing this, the user can get an additional communication channel for gauging, configuration and diagnostics.

# Appendix: Typical tank gauging configurations

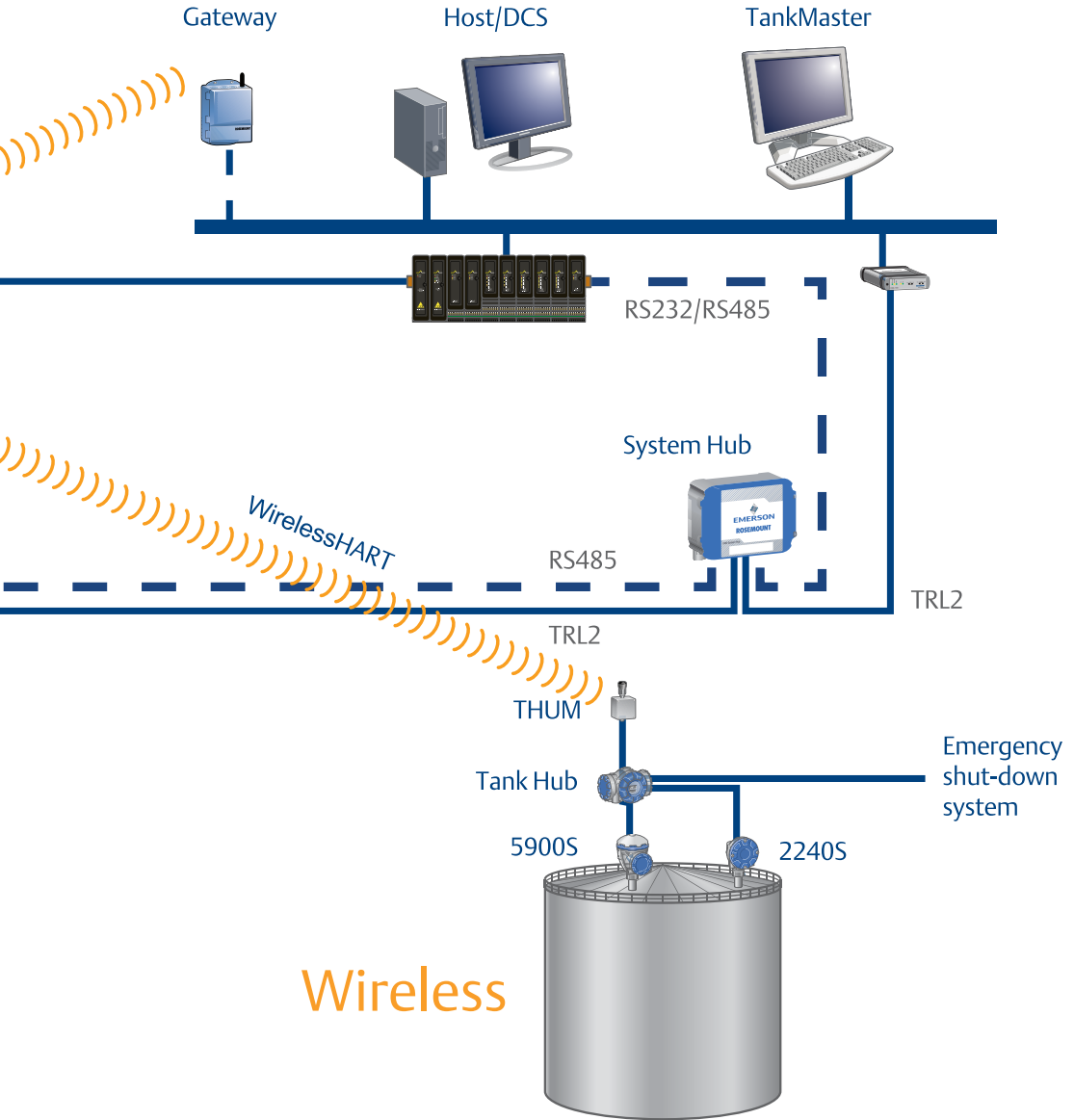

## A.4 Redundancy

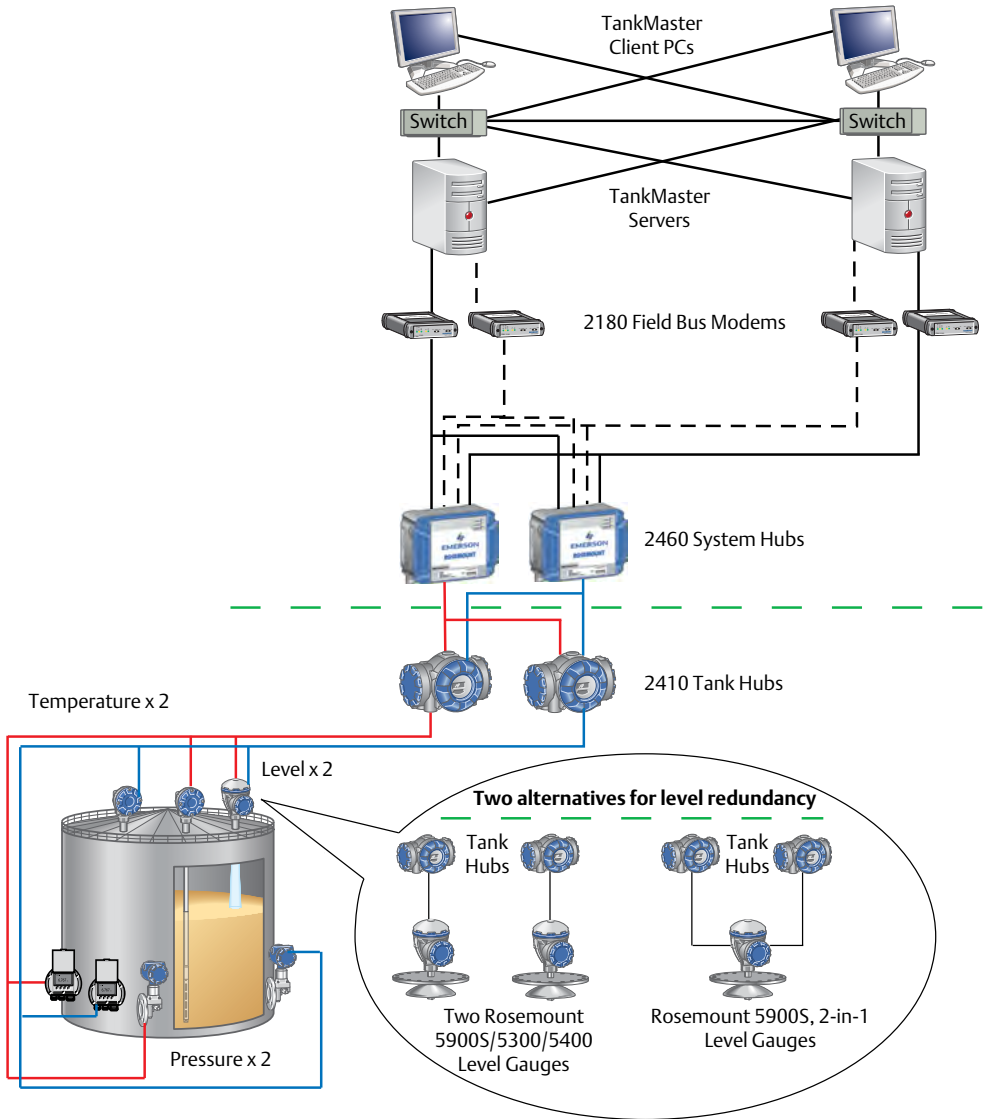

A fully redundant tank gauging system with four levels of redundancy: Tank unit redundancy and field communication unit redundancy combined with redundant data servers and redundant operator stations.



## A.5 Overfill Prevention

### Automatic Overfill Prevention System (AOPS) | Automatic Tank Gauging (ATG)

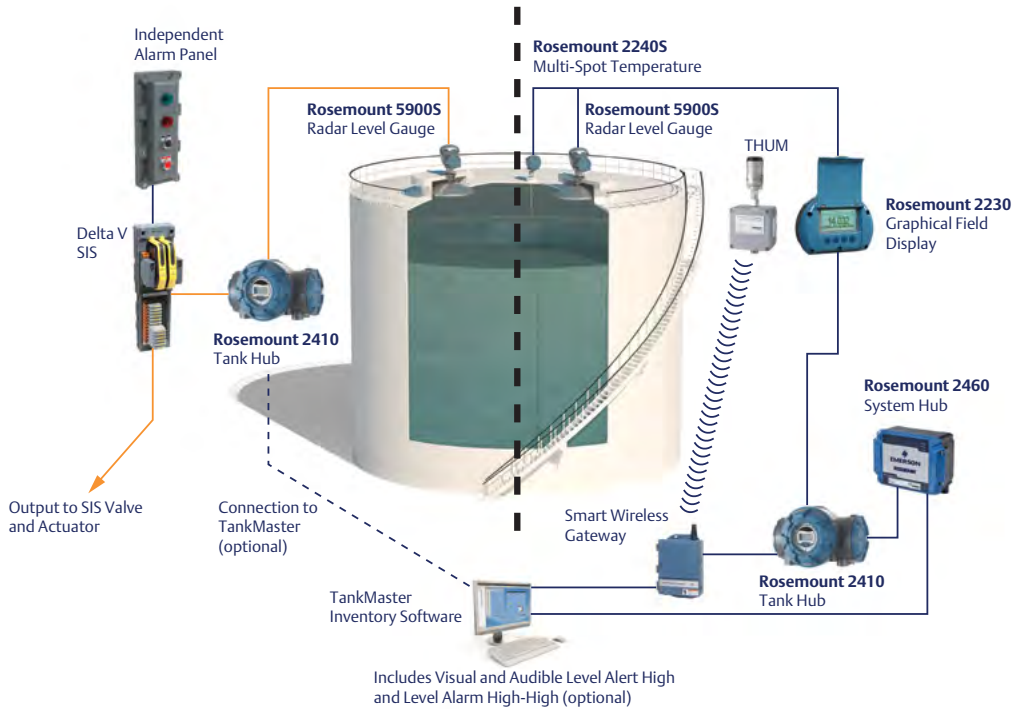

Example of a modern approach to overfill prevention, incorporating an automatic overfill prevention system based on continuous radar level measurement.

## A.6 Rosemount Tank Gauging System

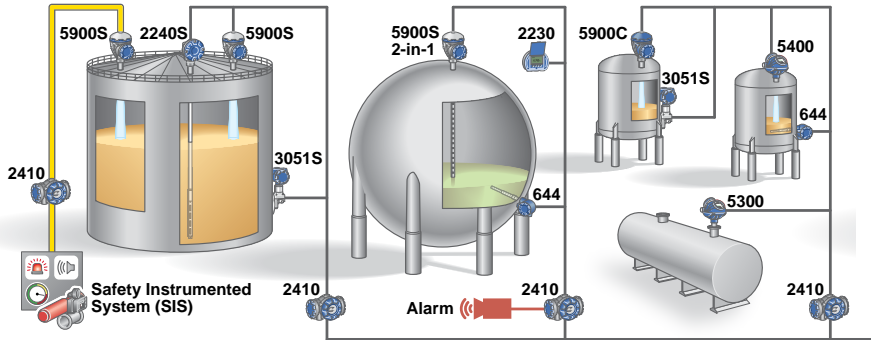

**Rosemount™ 5900S**  
Radar Level Gauge (2-in-1 option)

Still-pipe Array



Horn



Parabolic

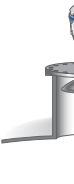

LPG/LNG



2-in-1



SIL 2 / SIL 3



SIL 2



**Rosemount 5900C**  
Radar Level Gauge

Still-pipe Array



Cone



Parabolic









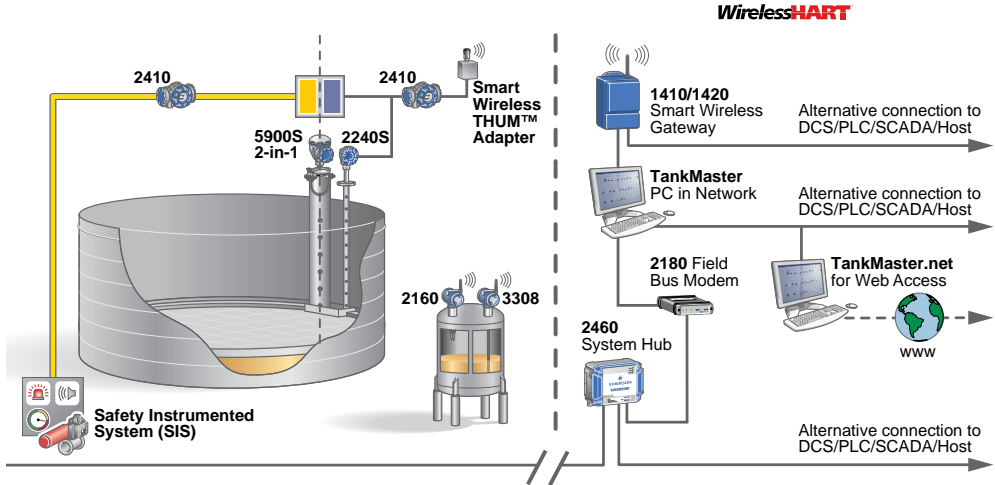

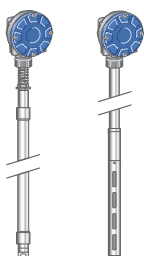

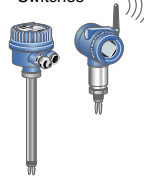

LPG/LNG



# Appendix: Typical tank gauging configurations



- |  |  |   |   |   |   |  |
|--|--|---|---|---|---|--|
| <p><b>2240S</b> Multi-input Temperature Transmitter</p>  | <p><b>Smart Wireless THUM™ Adapter</b></p>                            | <p><b>2120/2130/2160</b> Liquid Level Switches</p>  | <p><b>5400</b> Radar Level Transmitter</p>  | <p><b>5300</b> Guided Wave Radar Level Transmitter</p>  | <p><b>3308</b> Wireless Guided Wave Radar Level Transmitter</p>  |  |
| <p><b>565/566</b> Multiple Spot Temperature Sensor</p>  | <p><b>765</b> Multiple Spot Temperature and Water Level Sensor</p>  | <p><b>2230</b> Graphical Field Display</p>         | <p><b>2410</b> Tank Hub</p>                | <p><b>Field Communicator</b></p>                       | <p><b>3051S</b> Pressure Transmitter</p>                         | <p><b>644</b> Temperature Transmitter with 65 or 68 Single Point Temperature Sensor</p>  |





## References

| Topic | Page                           |
|-------|--------------------------------|
| R.1   | Literature references _____ 88 |
| R.2   | Figure references _____ 89     |



# References

## R.1 Literature references

American Petroleum Institute (1983) *Manual of Petroleum Measurement Standards*. Washington, D.C.

American Petroleum Institute (2012) *API 2350. Overfill Protection for Storage Tanks in Petroleum Facilities, Fourth Edition*. Washington D.C.

International Electrotechnical Commission (2016) *IEC 61511-1 Functional safety - Safety instrumented systems for the process industry sector*

International Organization for Standardization (2002) *ISO 4266-4:2002 - Petroleum and liquid petroleum products - Measurement of level and temperature in storage tanks by automatic methods*

International Organization for Standardization (2003) *ISO 15169:2003 - Petroleum and liquid petroleum products - Determination of volume, density and mass of the hydrocarbon content of vertical cylindrical tanks by hybrid tank measurement systems*

Marsh & McLennan Companies (2011) *Risk Engineering Position Paper – 01, Atmospheric Storage Tanks*. United Kingdom

Organisation Internationale de Métrologie Légale (2008) *OIML R 85-1 & 2 – Automatic level gauges for measuring the level of liquid in stationary storage tanks*. Paris.

### R.2 Figure references

**Figure 1.4** Photo by courtesy of the Center for Liquefied Natural Gas

**Figure 1.6** “File: Caribbean Petroleum Corporation Disaster.Jpg - Wikimedia Commons”. Commons.wikimedia.org. N.p., 2009. Web. 1 July 2016.

**Figure 2.2** Photo courtesy of Kalibra.

**Figure 10.1** “File: Buncefield.Jpg - Wikimedia Commons”. Commons.wikimedia.org. N.p., 2003. Web. 1 July 2016.

**Figure 10.3** “File: FEMA - 42315 - Firefighter At The Puerto Rico Gas Fire.Jpg - Wikimedia Commons”. Commons.wikimedia.org. N.p., 2009. Web. 5 July 2016.

**All other figures** Copyright Emerson © 2016





# About the authors



## **Lennart Hägg**

### **Former Technical Manager, Rosemount Tank Gauging**

Lennart Hägg is a former technical manager with Emerson's Rosemount Tank Gauging facility in Gothenburg, Sweden. He holds an MSc in Electronics Engineering from the Faculty of Engineering (LTH) at Lund University and has worked with radar based tank gauging in the petroleum industry since the technology was introduced in the 1980's. Hägg has participated in the API committee for tank gauging related standards and represented Sweden within the ISO 4266 standardization of level and temperature measurement in storage tanks. In addition, Hägg has been working with OIML in their development of recommendations for legal metrological requirements on level gauging.



## **Johan Sandberg**

### **Business Development Manager, Rosemount Tank Gauging**

Johan Sandberg holds an MSc in Electronics Engineering from the Institute of Technology at Linköping University, Sweden. His post-graduate engineering experience includes service as a Research Engineer at the Swedish National Defense Research Laboratories - Laser Division. Sandberg began working with high performance microwave based tank gauging in 1987 as a Systems Engineer at Saab Tank Control. Working on both marine and shore based radar tank gauging systems, he moved to the USA where he assumed the position of Technical Manager - North America. Towards the end of the 1990's, Sandberg was appointed Managing Director of the USA tank gauging operations in Houston, Texas. He is currently a Business Development Manager for Rosemount Tank Gauging based in Gothenburg, Sweden. During his career, Sandberg has gained vast experience in the field of tank gauging and overflow prevention solutions for the refinery and tank storage businesses.

# Acknowledgements

This handbook is the result of a joint effort between Emerson colleagues and customers around the world.

Thanks to all the Emerson tank gauging experts who gave their input to this project, and laid the foundation of the content.

Thank you also to all the unnamed contributors and all the Rosemount Tank Gauging users out there!



**What is tank gauging?**

Tank gauging technologies

Engineering standards and approvals

Volume and mass assessment

Accuracies and uncertainties

Temperature measurement

Liquefied gases

Additional sensors

**System architecture**

Overfill prevention

Appendix: Typical tank gauging configurations

References

# Global capabilities

## Global Headquarters and Europe Regional Office Tank Gauging

### Emerson Process Management

Box 150

(Visiting address: Layoutvägen 1)

SE-435 23 Mölnlycke

+46 31 337 00 00

Sales.RTG@Emerson.com



[Linkedin.com/company/Emerson-Process-Management](https://www.linkedin.com/company/Emerson-Process-Management)



[Twitter.com/Rosemount\\_News](https://twitter.com/Rosemount_News)



[Facebook.com/Rosemount](https://www.facebook.com/Rosemount)



[Youtube.com/user/RosemountMeasurement](https://www.youtube.com/user/RosemountMeasurement)



[Google.com/+RosemountMeasurement](https://www.google.com/+RosemountMeasurement)

## North America Regional Office Tank Gauging

### Emerson Process Management

6005 Rogerdale Road

Mail Stop NC 136

Houston, TX 77072, USA

+1 281 988 4000 or +1 800 722 2865

Sales.RTG.HOU@Emerson.com

## Latin America Regional Office

### Emerson Process Management

1300 Concord Terrace, Suite 400

Sunrise, FL 33323, USA

+1 954 846 5030

RMTLAContactUS@emerson.com

## Asia Pacific Regional Office

### Emerson Process Management Asia Pacific Pte Ltd

1 Pandan Crescent

Singapore 128461

+65 6777 8211

Specialist-OneLevel.RMT-AP@AP.Emerson.com

## Middle East and Africa Regional Office

### Emerson Process Management

Emerson FZE P.O. Box 17033,

Jebel Ali Free Zone - South 2

Dubai, United Arab Emirates

+971 4 8118100

RTGMEA.Sales@Emerson.com

## EmersonProcess.com/Rosemount

The Emerson logo is a trademark and service mark of Emerson Electric Co. TankMaster, Emerson, THUM Adapter, Rosemount and Rosemount logotype are trademarks of Emerson Process Management. WirelessHART is a registered trademark of the FieldComm Group. All other marks are the property of their respective owners. © 2016 Emerson Process Management. All rights reserved.

00805-0100-5100, Rev AA 08/16

ROSEMOUNT™

